

TECHNICAL INFORMATION

MCE & MSCE MINI ELECTRIC CYLINDERS & SLIDERS



Index

GENERAL INFORMATION	4
Product overview	4
Accessory overview	6
TECHNICAL INFORMATION	9
Mini electric cylinder MCE	9
Operating conditions	9
Maximum lateral loading as a function of the piston rod absolute position	9
Maximum deflection of the piston rod end as a function of the cylinder absolute stroke	10
Maximum horizontal payload as a function of the travel speed and acceleration of the piston rod	11
Maximum vertical payload as a function of the travel speed and acceleration of the piston rod	13
Maximum axial load as a function of the travel speed and acceleration of the piston rod	15
Maximum horizontal payload as a function of change of the position and positioning time of the piston rod	17
Maximum vertical payload as a function of change of the position and positioning time of the piston rod	19
Absolute stroke and length of the MCE definition	21
Mini electric slider MSCE	22
Operating conditions	22
Maximum lateral loading as a function of the slide absolute position	22
Angular deflections of the front plate as a function of the slide's absolute position	23
Deflections of the front plate as a function of the slide's absolute position	24
Maximum horizontal payload as a function of the travel speed and acceleration of the front plate	26
Maximum vertical payload as a function of the travel speed and acceleration of the front plate	28
Maximum axial load as a function of the travel speed and acceleration of the front plate	30
Maximum horizontal payload as a function of change of the position and positioning time of the front plate	32
Maximum vertical payload as a function of change of the position and positioning time of the front plate	34
Absolute stroke and length of the MSCE definition	36
Motor types and sizes	37
Drive types	39
Drive-motor cables	41
Power and signal cables	43
MOUNTING EXAMPLES	44
x-y configuration with the x-axis: MCE + the guiding unit GUC	44
x-z configuration with the x-axis: MCE + the guiding unit GUC	45
x-y configuration with the x-axis: MSCE (y-axis is mounted to the front plate)	45
x-y configuration with the x-axis: MSCE (y-axis is mounted to the slide)	46
x-z configuration with the x-axis: MSCE (z-axis is mounted to the front plate)	46

SERVICE LIFE	47
Linear guiding	47
Permissible load	48
Service life	48
Ball screw drive	50
Permissible load	50
Service life	50
Mini electric cylinder MCE	52
Mini electric slider MSCE	52
CALCULATIONS	53
Load torque	53
ORDER CODES	54
MCE	54
MSCE	56
Motor Adapter VK	58
Motor side drive MSD with a timing belt	59
Guiding Unit	60
Couplings	61

Information in this document is subject to change. Owing to continued product development, Rollco reserves the right to make alterations without prior notice. Every care has been taken to ensure the accuracy of the information, but no liability can be accepted for any errors or omissions.

All information and content included in this document, such as text, and images, are property of Rollco. Any reproduction, even partial, is allowed only by written permission by Rollco.

Product overview

Characteristics

Mini electric cylinder and sliders are small linear drives. The MCE has a piston rod and the MSCE has an integrated linear guiding system and slide.

By using an integrated precision ball screw drive, the rotary motion (rotation) of the drive shaft is converted to linear motion (translation) of the piston rod or slide with high mechanical efficiency and low internal friction.

High-performance features such as high speed, good positioning accuracy, and high repeatability are ensured through a precision ball screw drive and an anti-rotating piston rod device or a linear guiding system.

A preassembled standard motor (in-line with a motor adapter and a coupling or in-parallel with a motor side drive and a timing belt) together with the standard drive, makes the system plug and play ready. Compact dimensions and optimally selected motor combinations cover a wide range of applications.

The aluminium cylinder profile includes T-slots on the bottom for fixing the electric cylinder/slider, as well as side slots for clamping fixtures and magnetic field sensors.

Excellent price-performance ratio and a quick delivery time, due to standard lengths, are ensured.

Each MCE/MSCE is optimally pre-lubricated and ready for a maintenance-free operating process. MCE/MSCE allows relatively high load capacities and optimal cycles for moving the larger payloads at high speeds in both horizontal and vertical directions.

The aluminium profiles are manufactured according to the medium EN 12020-2 standard.

Motor adapter VK with a coupling and a motor

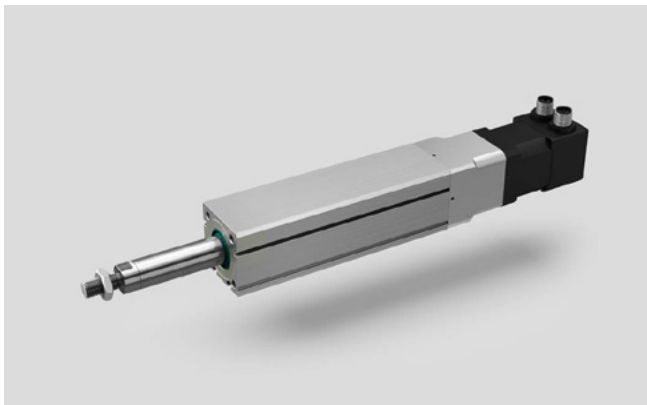

MCE

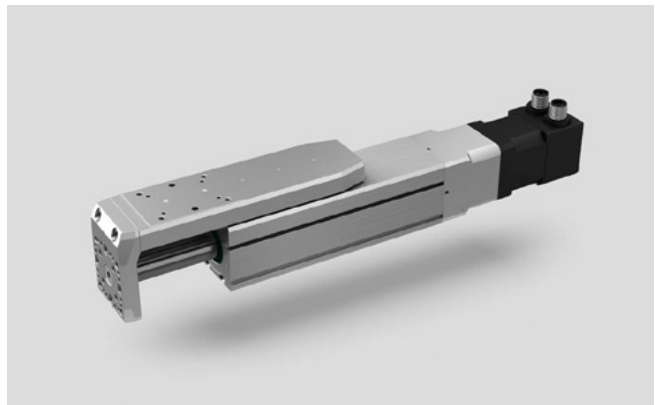

MSCE

Motor side drive with timing a belt and a motor

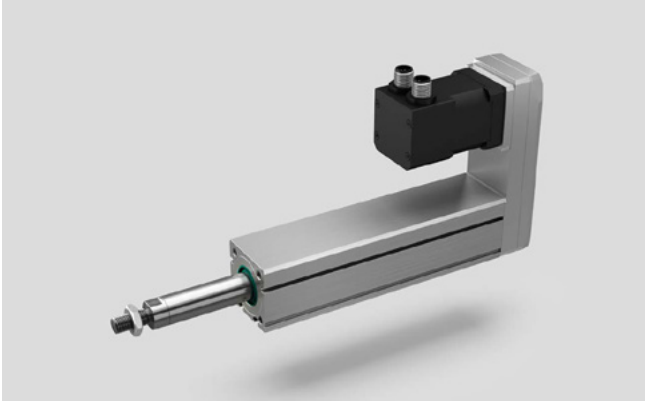

MCE



MSCE

Multi-axis system

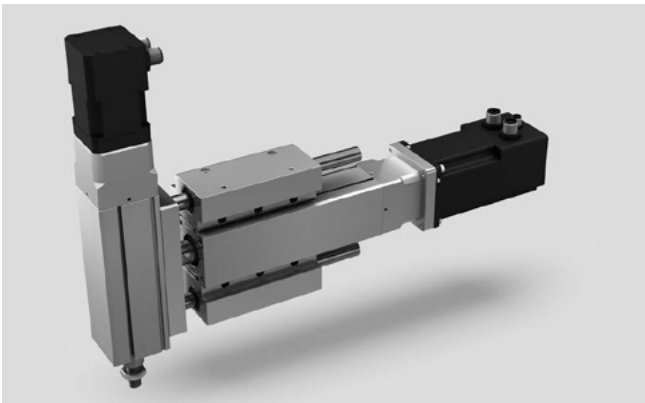

MCE (guiding unit GUC is used)

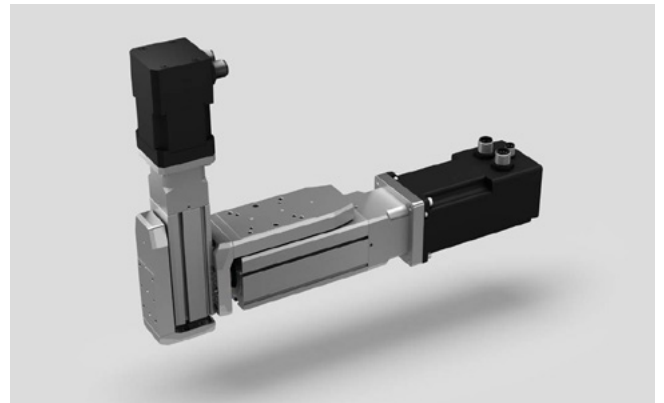

MSCE

Accessories

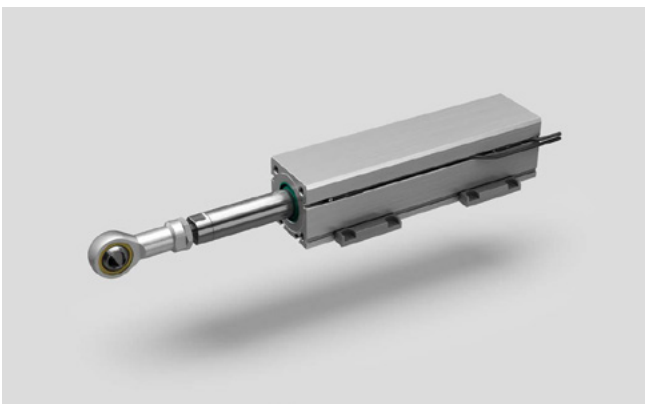

MCE (without a preassembled motor)

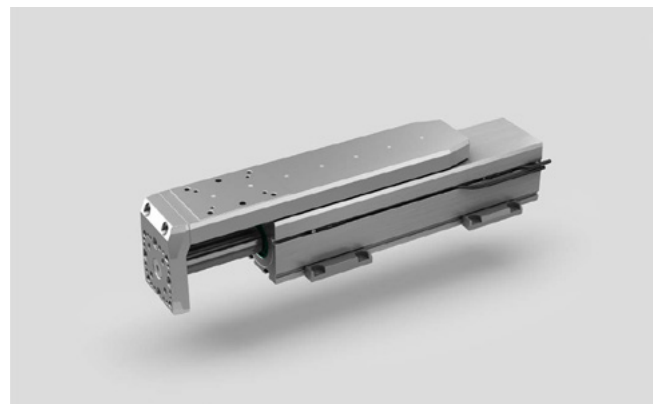

MSCE (without a preassembled motor)

Accessory overview

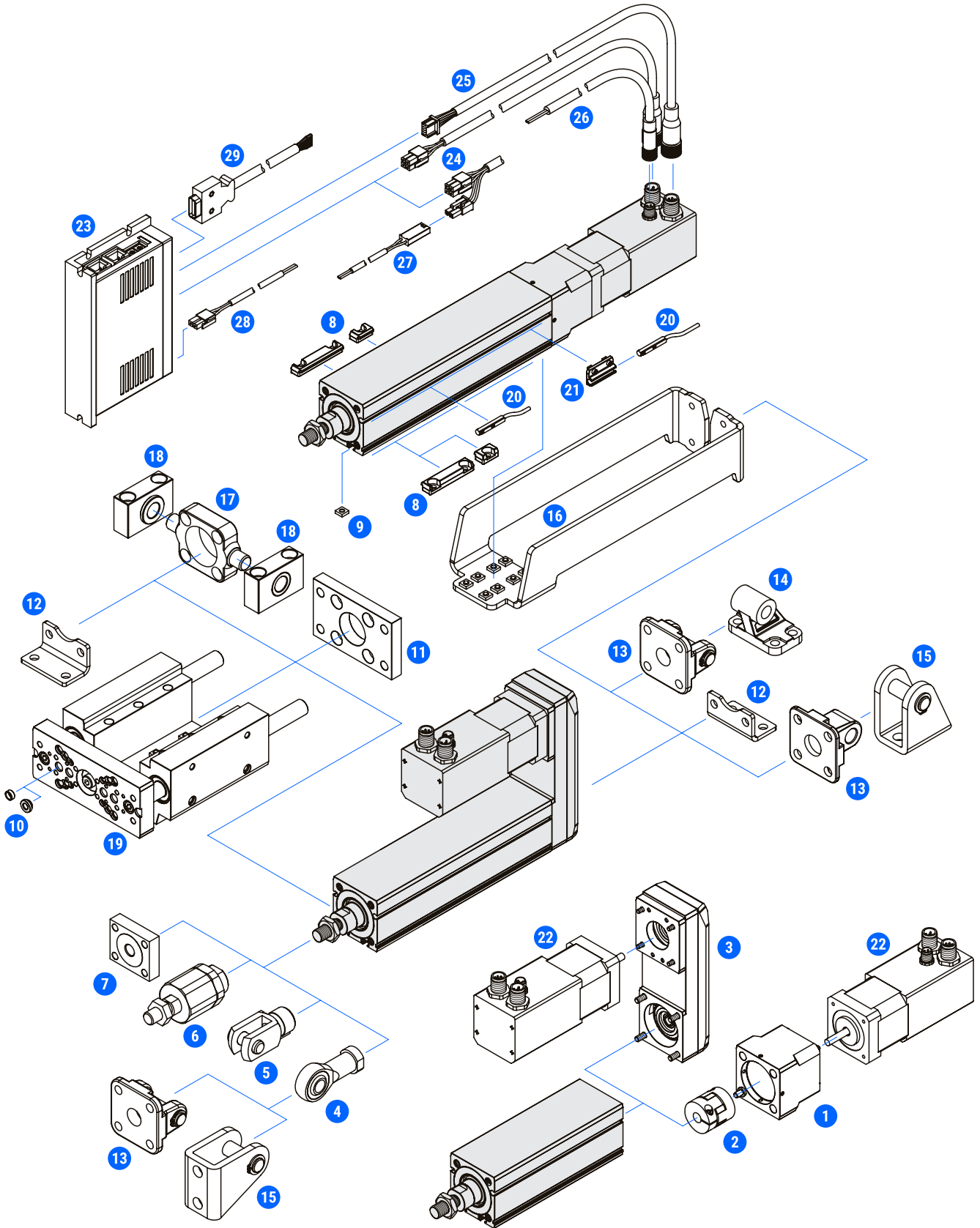

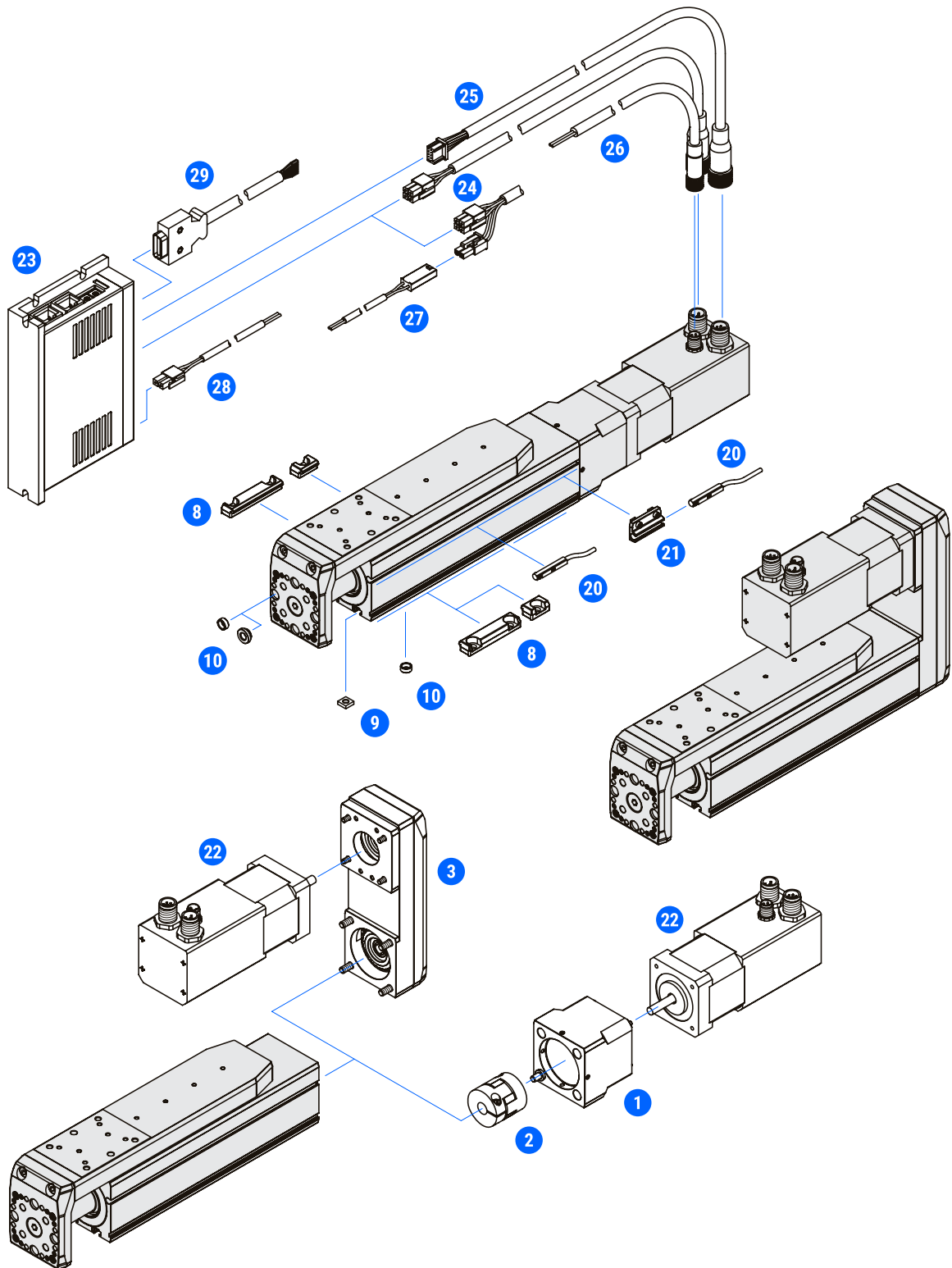

#	Accessories	Compatible with MCE/MSCE size			Type
		25	32	45	
1	Motor adapter VK	•	•	•	Motor adapters
2	Coupling	•	•	•	Elastomer couplings
3	Motor side drive MSD	•	•	•	Motor side drives
4	Rod eye SGS	•	•	•	Piston rod accessories
5	Rod clevis SG	•	•	•	
6	Self-aligning joint FK	•	•	•	
7	Coupling piece KSZ	•	•	•	
8	Clamping fixture	•	•	•	
9	Slot nut	•	•	•	Mounting attachment accessories
10	Centering ring	•	•	•	
11	Flange mounting MAFL	•	•	•	
12	Foot mounting MAHP	•	•	•	
13	Swivel/clevis mount MASU	•	•	•	
14	Swivel foot mounting MLG	-	-	•	
15	Clevis foot mounting MLBU	•	•	-	
16	Back mount ABM	•	•	•	
17	Trunnion mount MZK	-	•	•	
18	Trunnion support MLZ	-	•	•	Guiding units
19	Guiding unit GUC	•	•	•	
20	Magnetic field sensor	•	•	•	Limit switches
21	Sensor holder HMG	•	-	-	
22	Motor	•	•	•	Motors
23	Drive	•	•	•	Drives
24	Motor cable	•*	•*	•	Cables
25	Encoder cable	•	•	•	
26	Brake cable	•*	•*	•	
27	Brake to terminal cable*	•	•	-	
28	Power cable	•	•	•	
29	Signal cable	•	•	•	

*For the stepper motor size of 28, the motor and brake cables are combined into one cable. For connectivity between the brake and terminal, an additional brake to terminal cable is used.

Mini electric cylinder MCE

Operating conditions

Ambient temperature	0 °C ~ +50 °C
Ambient temperature without a motor	0 °C ~ +60 °C
Protection class	IP40
Duty cycle	100 %
Maintenance	Life-time pre-lubricated

Maximum lateral loading as a function of the piston rod absolute position

On the following diagrams, the maximum lateral loads acting on the piston rod end as a function of the piston rod absolute position for different values of the absolute stroke are presented. There is also an extended piston rod (E) taken into consideration.

Values on the curves represent an absolute stroke of the cylinder. Diagrams consider the maximum travel speed of the particular size of the cylinder. When operating with lower travel speeds, the maximum lateral load may be higher.

Diagrams consider the maximum travel speed of the particular size of the cylinder. When operating with lower travel speeds, the maximum lateral load may be higher.

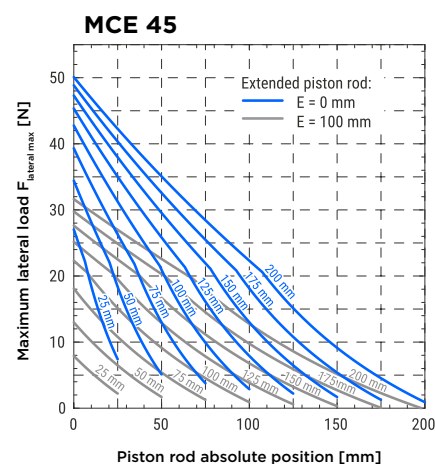
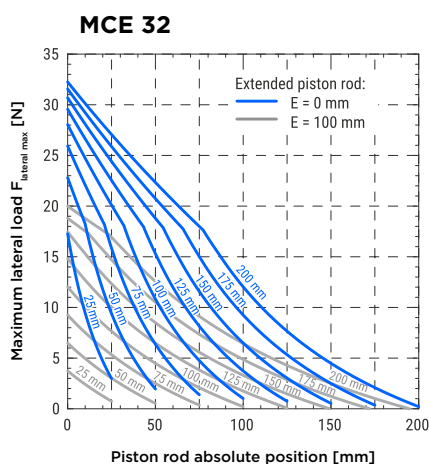
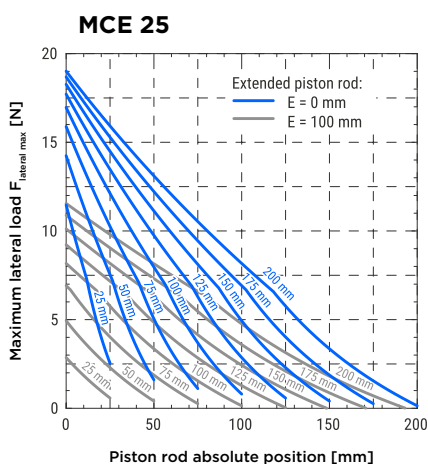
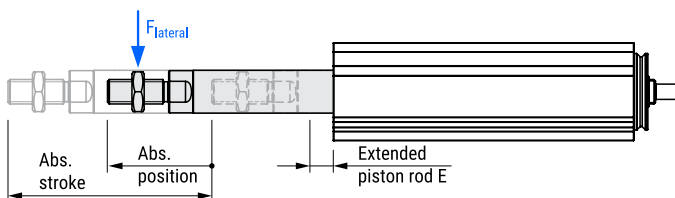

Maximum deflection of the piston rod end as a function of the cylinder absolute stroke

On the following diagrams, the maximum deflections of the piston rod end subjected to different lateral loads for different absolute positions (defined as a portion of the absolute stroke) are presented. There is also an extended piston rod (E) taken into consideration.

Values on the curves represent lateral load applied to the piston rod end.

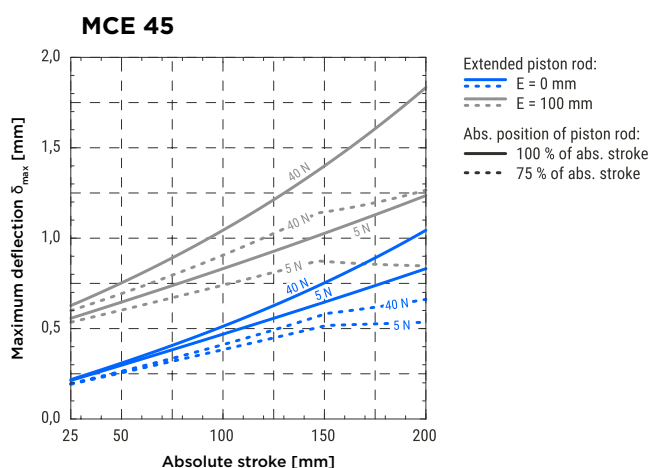
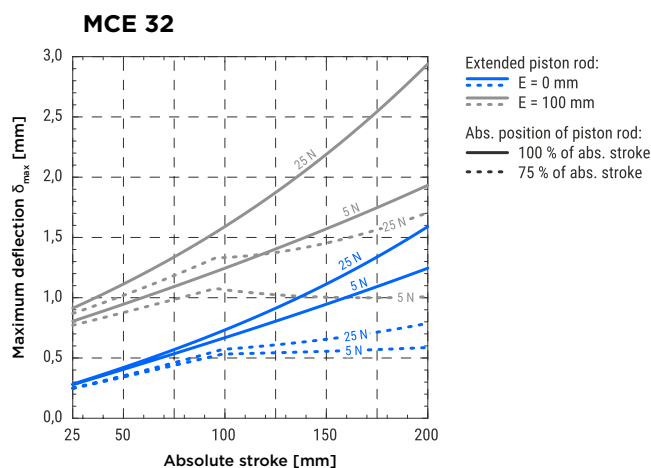
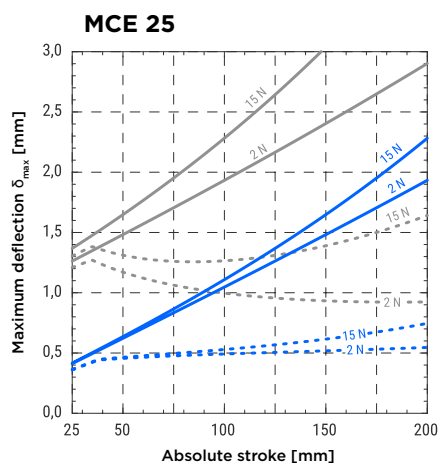
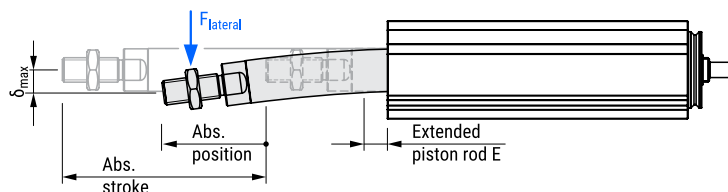

Maximum horizontal payload as a function of the travel speed and acceleration of the piston rod

On the following diagrams, the maximum horizontal payloads applied to the piston rod as a function of the travel speed for different accelerations, different ball screw leads and different combinations of the standard motors are presented. Motor adapter VK and a motor side drive MSD are also considered.

Diagrams are valid when the payload is supported by an external guiding (coefficient of friction 0,1 has been considered).

It should be noted that the diagrams are also valid for the case where a guiding unit GUC is considered.

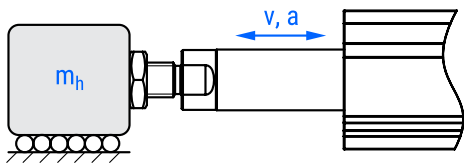

MCE 25

6 × 2 with a stepper motor □28

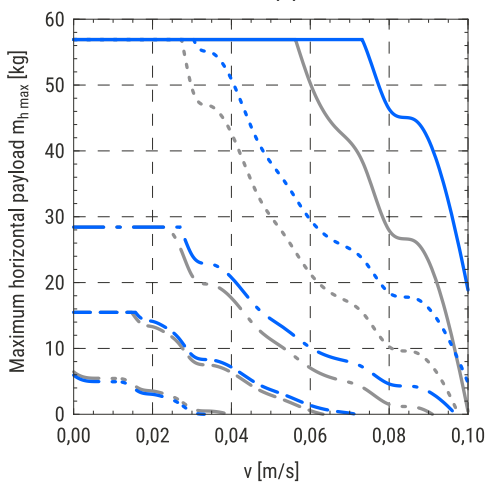

6 × 6 with a stepper motor □28

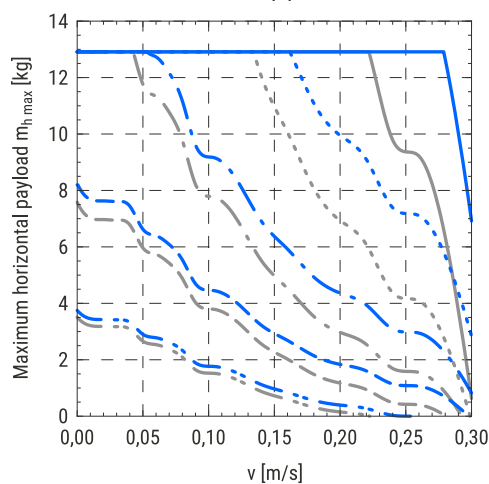

MCE in combination:
 — with VK
 — with MSD

Acceleration/Deceleration:
 — a = 0,5 m/s²
 - - - a = 2 m/s²
 - · - · a = 5 m/s²
 - - - a = 10 m/s²
 - · - · a = 20 m/s²

MCE 32

8 × 2 with a stepper motor □28

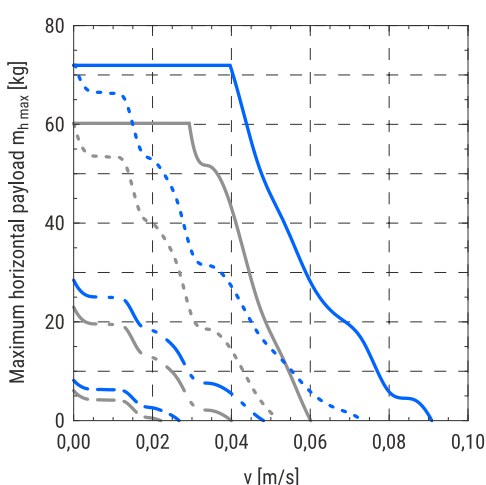

8 × 8 with a stepper motor □28

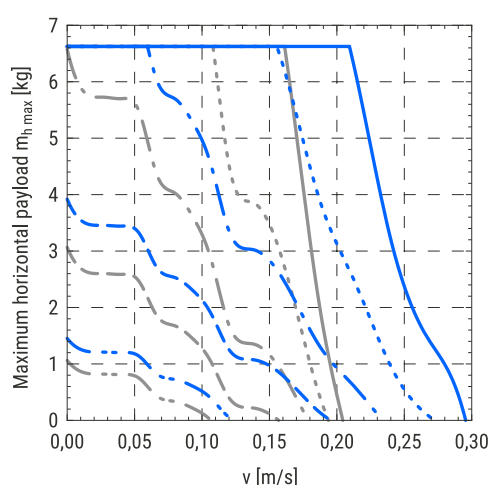

MCE in combination:
 — with VK
 — with MSD

Acceleration/Deceleration:
 — a = 0,5 m/s²
 - - - a = 2 m/s²
 - · - · a = 5 m/s²
 - - - a = 10 m/s²
 - · - · a = 20 m/s²

8 × 2 with a stepper motor □42

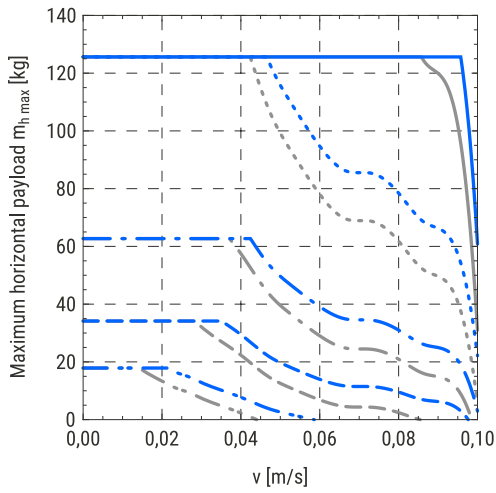

8 × 8 with a stepper motor □42

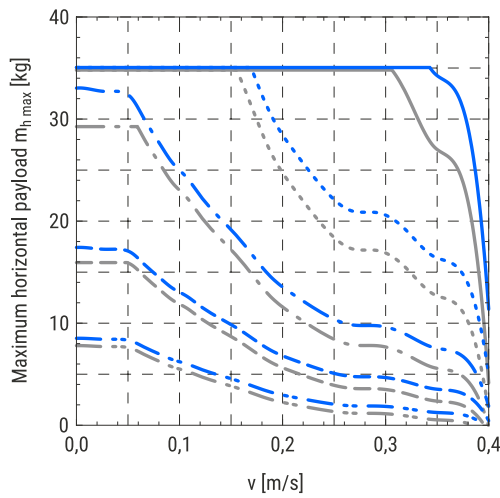

MCE in combination:
 — with VK
 — with MSD

Acceleration/Deceleration:
 — a = 0,5 m/s²
 - - - a = 2 m/s²
 - · - a = 5 m/s²
 - - - a = 10 m/s²
 - · - a = 20 m/s²

MCE 45

10 × 3 with a stepper motor □42

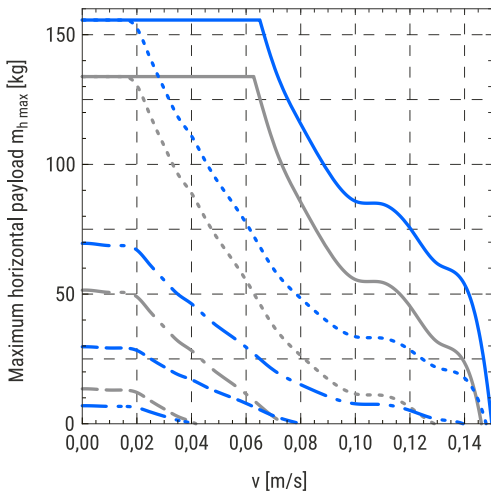

10 × 10 with a stepper motor □42

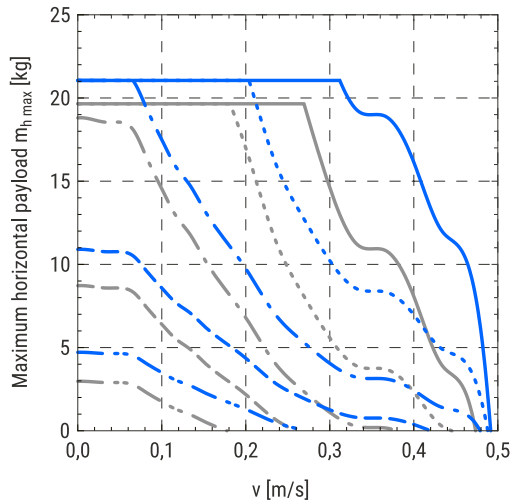

MCE in combination:
 — with VK
 — with MSD

Acceleration/Deceleration:
 — a = 0,5 m/s²
 - - - a = 2 m/s²
 - · - a = 5 m/s²
 - - - a = 10 m/s²
 - · - a = 20 m/s²

10 × 3 with a stepper motor □56

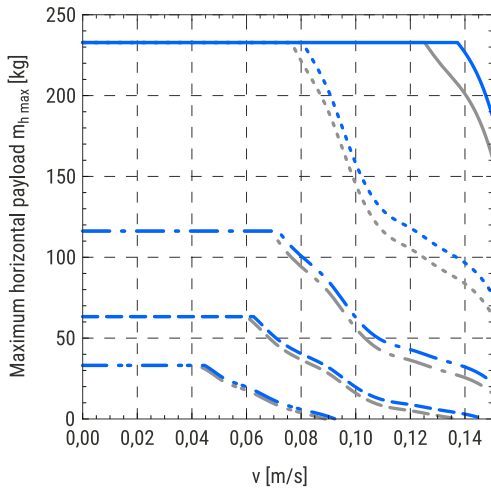

10 × 10 with a stepper motor □56

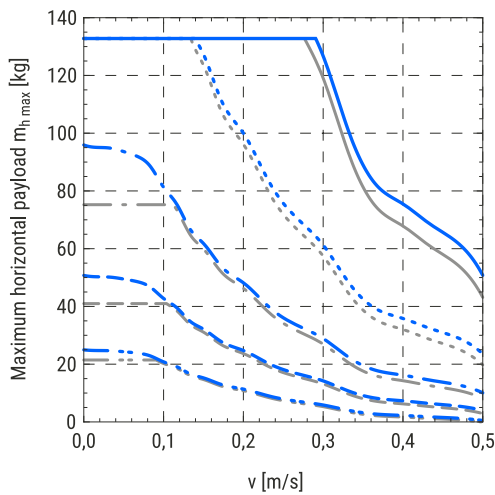

MCE in combination:
 — with VK
 — with MSD

Acceleration/Deceleration:
 — a = 0,5 m/s²
 - - - a = 2 m/s²
 - · - a = 5 m/s²
 - - - a = 10 m/s²
 - · - a = 20 m/s²

Maximum vertical payload as a function of the travel speed and acceleration of the piston rod

On the following diagrams, the maximum vertical payloads applied to the piston rod as a function of the travel speed for different accelerations, different ball screw leads and different combinations of the standard motors are presented. Motor adapter VK and a motor side drive MSD are also considered.

For the case that guiding unit GUC is taken into consideration, the value obtained from the diagram should be decreased by the moving mass of the guiding unit (please refer to the Guiding unit section).

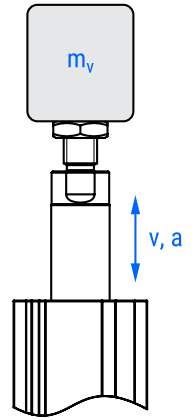

MCE 25

6 × 2 with a stepper motor □28

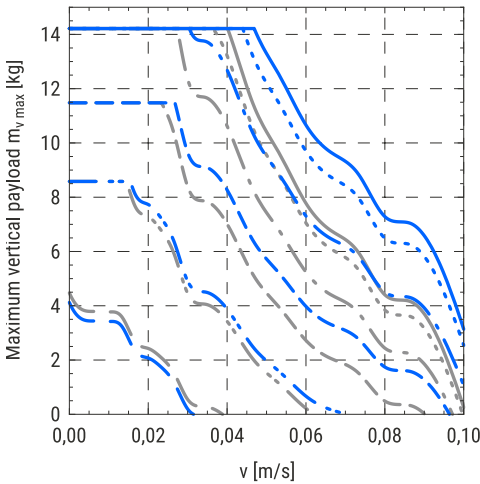

6 × 6 with a stepper motor □28

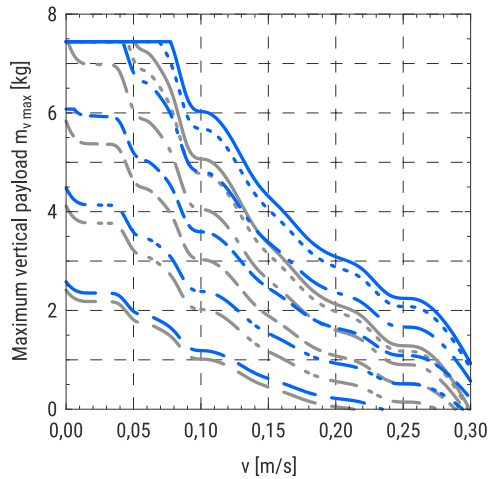

MCE in combination:

— with VK
 - - - with MSD

Acceleration/Deceleration:

— a = 0 m/s²
 - - - a = 0,5 m/s²
 - · - a = 2 m/s²
 - - - a = 5 m/s²
 - · · - a = 10 m/s²
 - - - a = 20 m/s²

MCE 32

8 × 2 with a stepper motor □28

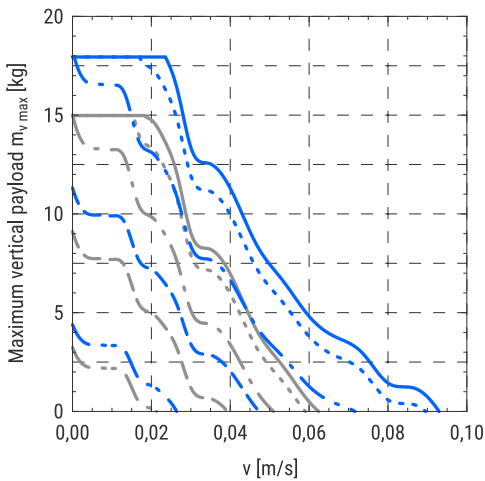

8 × 8 with a stepper motor □28

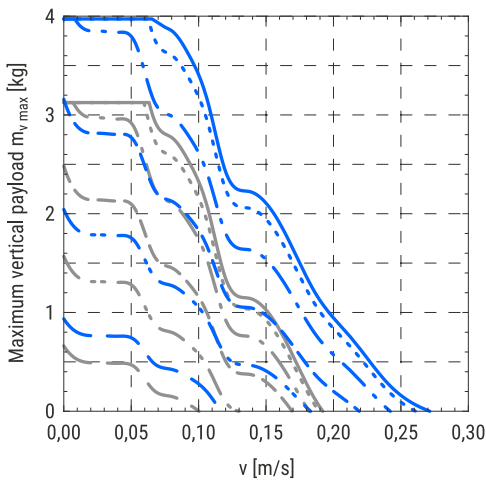

MCE in combination:

— with VK
 - - - with MSD

Acceleration/Deceleration:

— a = 0 m/s²
 - - - a = 0,5 m/s²
 - · - a = 2 m/s²
 - - - a = 5 m/s²
 - · · - a = 10 m/s²
 - - - a = 20 m/s²

8 × 2 with a stepper motor □42

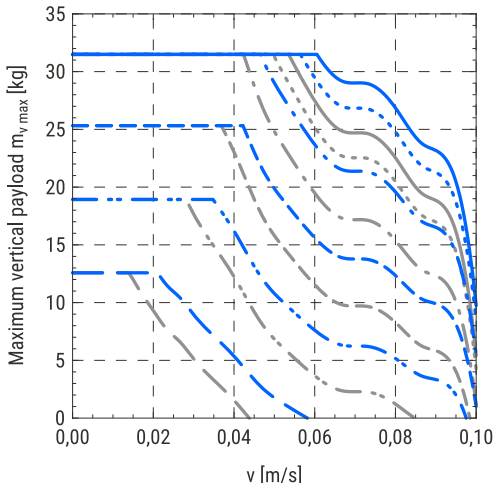

8 × 8 with a stepper motor □42

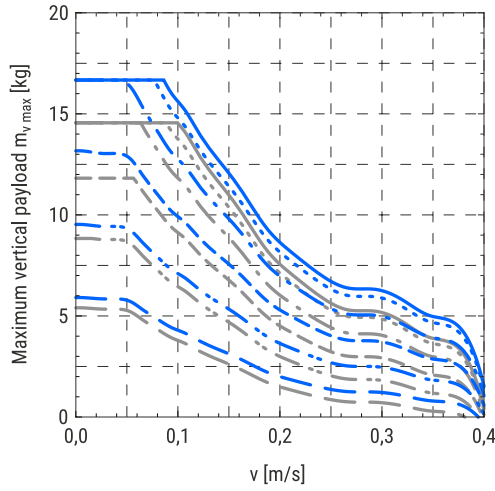

MCE in combination:
 — with VK
 — with MSD

Acceleration/Deceleration:
 — a = 0 m/s²
 - - - a = 0,5 m/s²
 - · - a = 2 m/s²
 - - - a = 5 m/s²
 - · - a = 10 m/s²
 - - - a = 20 m/s²

MCE 45

10 × 3 with a stepper motor □42

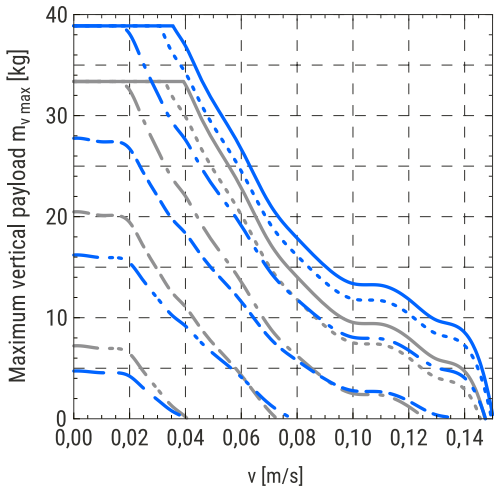

10 × 10 with a stepper motor □42

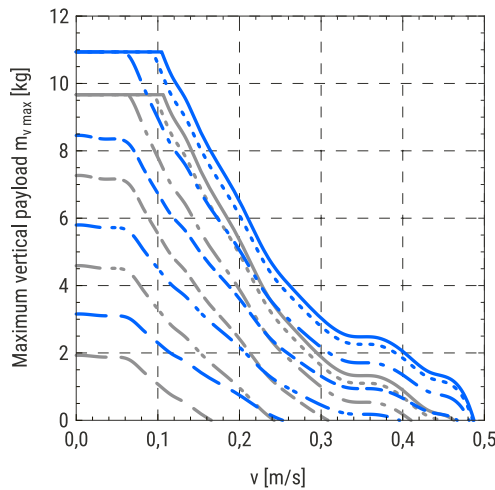

MCE in combination:
 — with VK
 — with MSD

Acceleration/Deceleration:
 — a = 0 m/s²
 - - - a = 0,5 m/s²
 - · - a = 2 m/s²
 - - - a = 5 m/s²
 - · - a = 10 m/s²
 - - - a = 20 m/s²

10 × 3 with a stepper motor □56

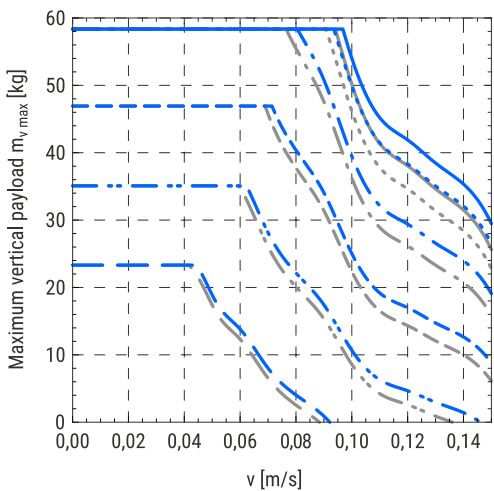

10 × 10 with a stepper motor □56

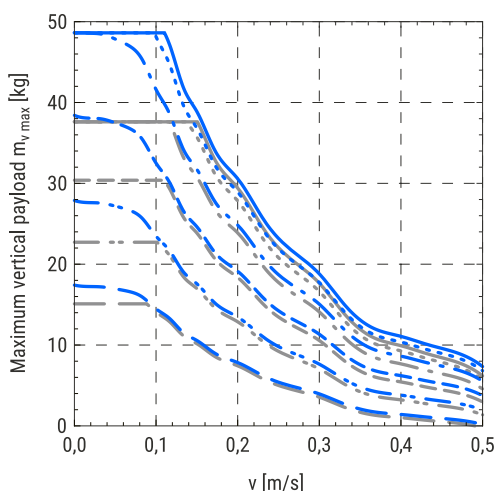

MCE in combination:
 — with VK
 — with MSD

Acceleration/Deceleration:
 — a = 0 m/s²
 - - - a = 0,5 m/s²
 - · - a = 2 m/s²
 - - - a = 5 m/s²
 - · - a = 10 m/s²
 - - - a = 20 m/s²

Maximum axial load as a function of the travel speed and acceleration of the piston rod

On the following diagrams, the maximum axial load applied to the piston rod as a function of the travel speed for different accelerations, different ball screw leads and different combinations of the standard motors is presented. Motor adapter VK and a motor side drive MSD are also considered.

For the case where a guiding unit GUC is used, the value obtained from the diagram should be decreased by the moving mass of the guiding unit (please refer to the Guiding unit section) multiplied by the acceleration of the piston rod.

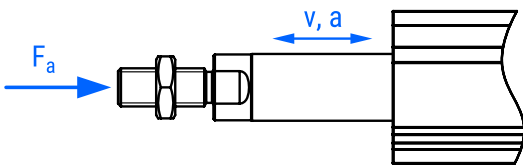

MCE 25

6 × 2 with a stepper motor □28

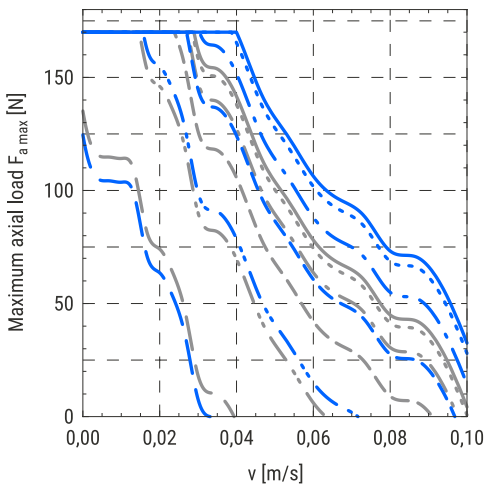

6 × 6 with a stepper motor □28

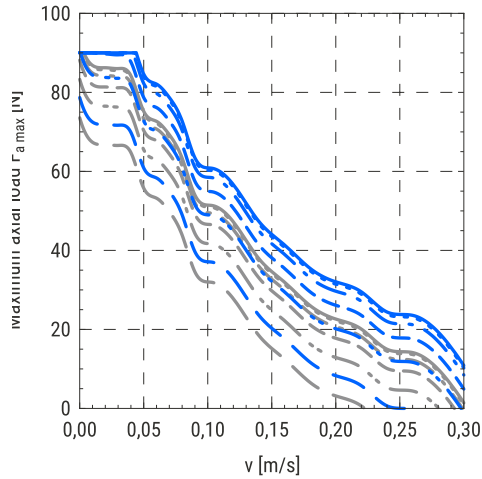

MCE in combination:
 — with VK
 - - - with MSD

Acceleration/Deceleration:
 — a = 0 m/s²
 - - - a = 0,5 m/s²
 - · - a = 2 m/s²
 - - - a = 5 m/s²
 - · - a = 10 m/s²
 - - - a = 20 m/s²

MCE 32

8 × 2 with a stepper motor □28

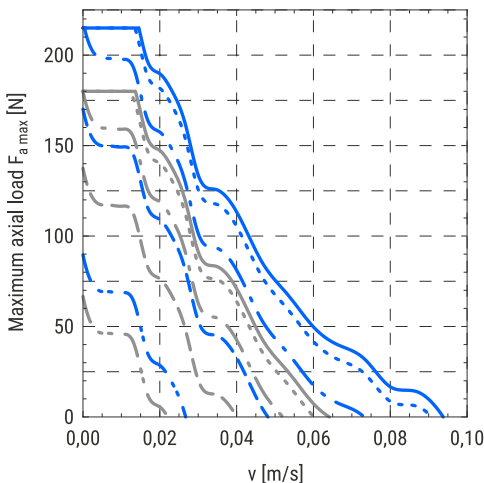

8 × 8 with a stepper motor □28

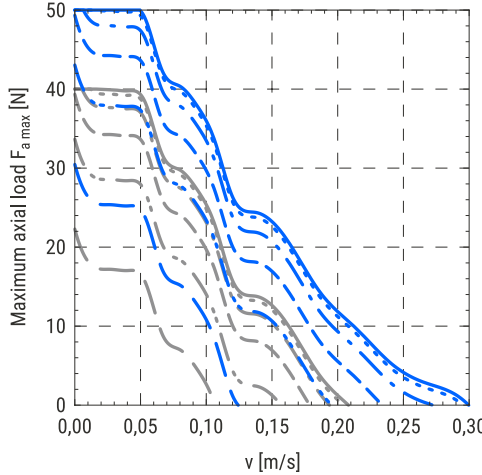

MCE in combination:
 — with VK
 - - - with MSD

Acceleration/Deceleration:
 — a = 0 m/s²
 - - - a = 0,5 m/s²
 - · - a = 2 m/s²
 - - - a = 5 m/s²
 - · - a = 10 m/s²
 - - - a = 20 m/s²

8 × 2 with a stepper motor □42

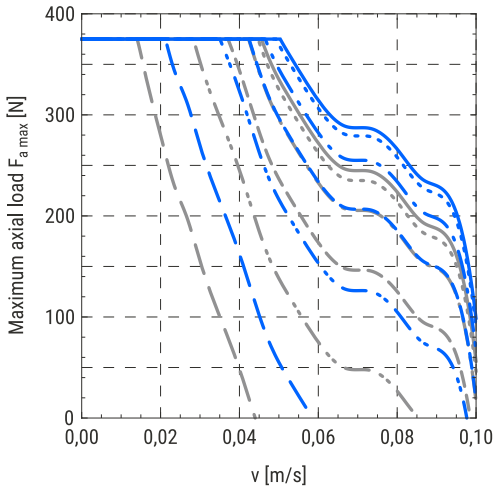

8 × 8 with a stepper motor □42

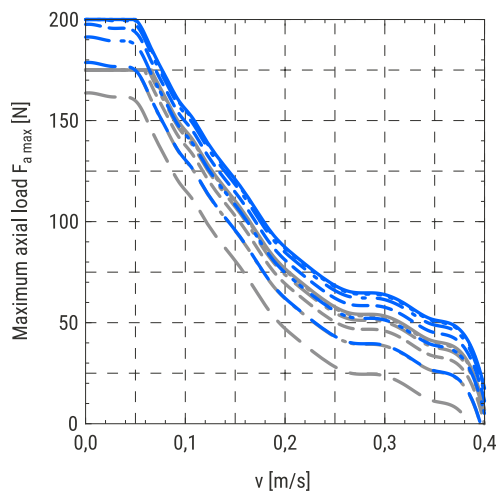

MCE in combination:
 — with VK
 — with MSD

Acceleration/Deceleration:
 — a = 0 m/s²
 - - - a = 0,5 m/s²
 - · - a = 2 m/s²
 - - - a = 5 m/s²
 - · - a = 10 m/s²
 - - - a = 20 m/s²

MCE 45

10 × 3 with a stepper motor □42

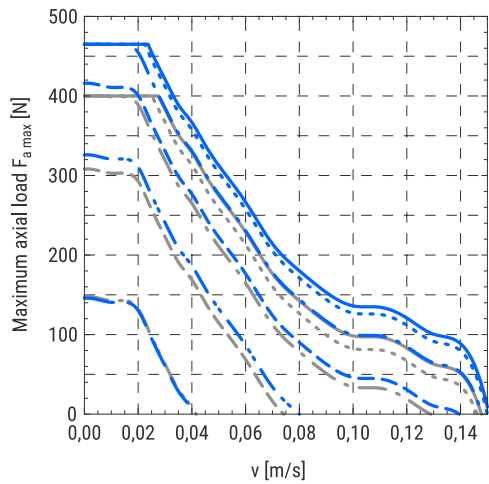

10 × 10 with a stepper motor □42

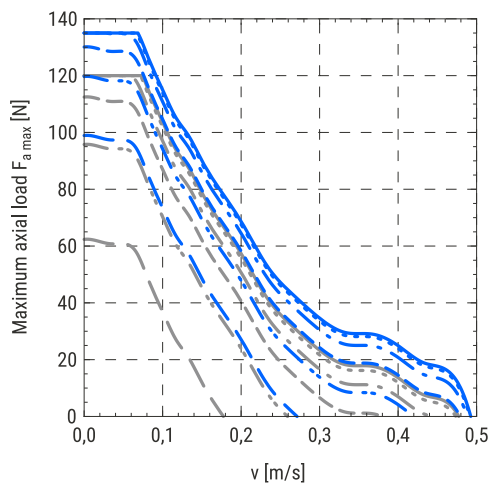

MCE in combination:
 — with VK
 — with MSD

Acceleration/Deceleration:
 — a = 0 m/s²
 - - - a = 0,5 m/s²
 - · - a = 2 m/s²
 - - - a = 5 m/s²
 - · - a = 10 m/s²
 - - - a = 20 m/s²

10 × 3 with a stepper motor □56

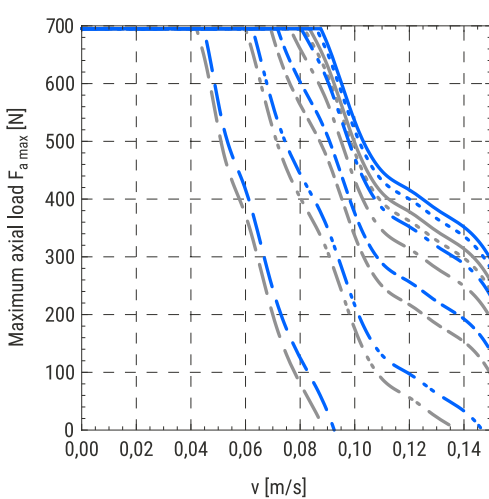

10 × 10 with a stepper motor □56

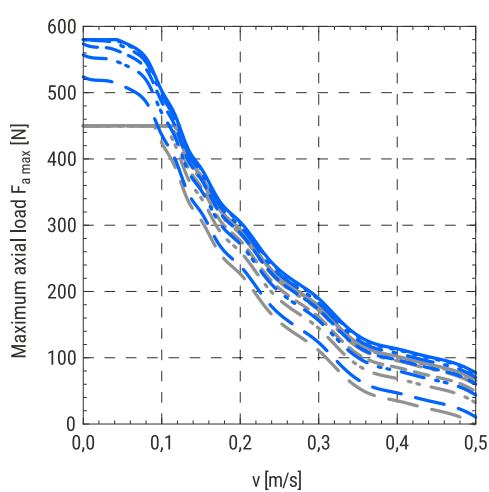

MCE in combination:
 — with VK
 — with MSD

Acceleration/Deceleration:
 — a = 0 m/s²
 - - - a = 0,5 m/s²
 - · - a = 2 m/s²
 - - - a = 5 m/s²
 - · - a = 10 m/s²
 - - - a = 20 m/s²

Maximum horizontal payload as a function of change of the position and positioning time of the piston rod

The following diagrams show the maximum payload that can be moved by a certain horizontal distance within a positioning time frame. Acceleration/deceleration time of 100 ms is taken into account.

Diagrams depend on the ball screw leads and different combinations of the standard motors. Motor adapter VK and a motor side drive MSD are also considered.

Diagrams are valid when the payload is supported by an external guiding (coefficient of friction 0,1 has been considered).

It should be noted that the diagrams are also valid for the case where a guiding unit GUC is considered.

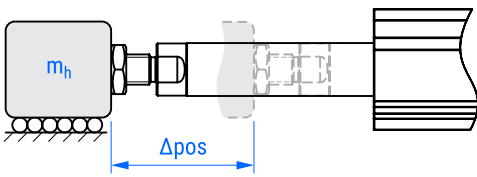

MCE 25

6 × 2 with a stepper motor □28

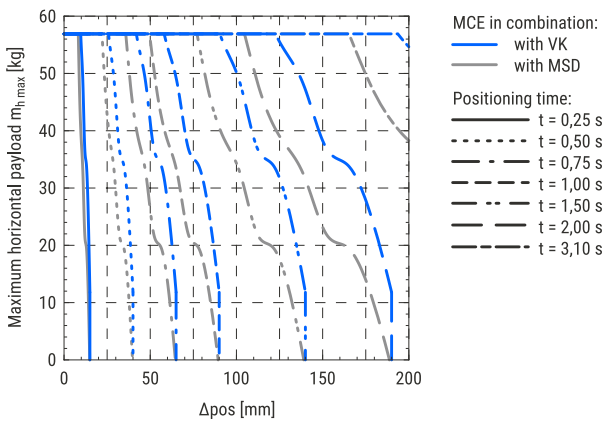

6 × 6 with a stepper motor □28

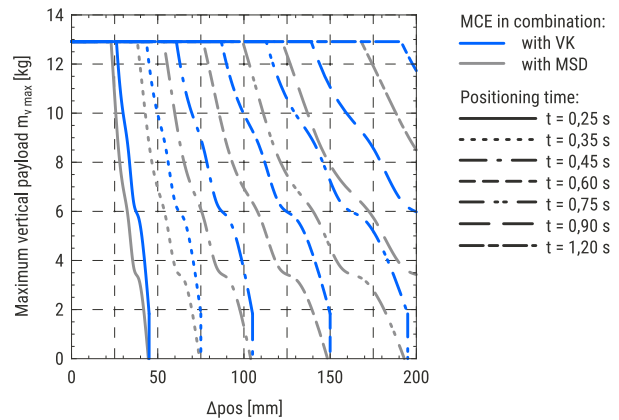

MCE 32

8 × 2 with a stepper motor □28

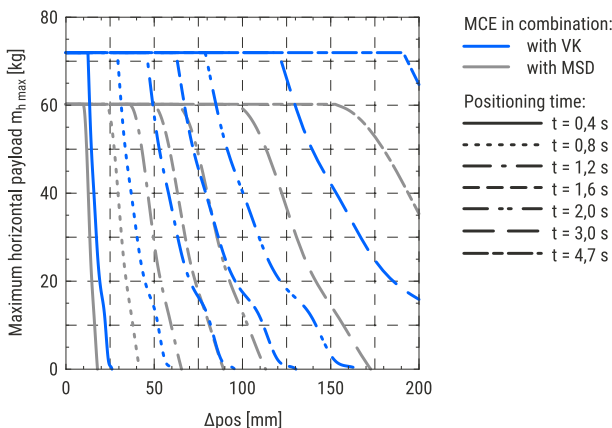

8 × 8 with a stepper motor □28

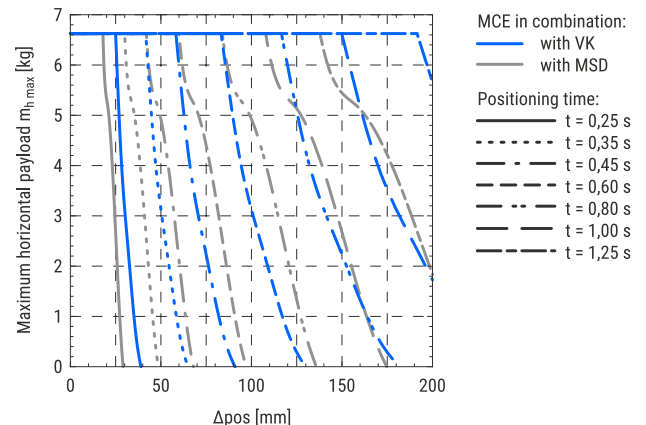

8 × 2 with a stepper motor □42

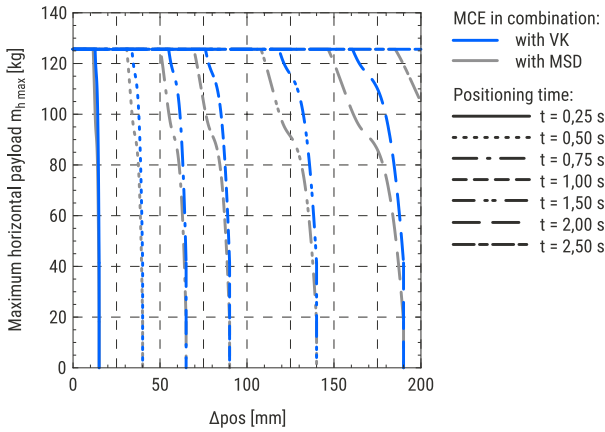

8 × 8 with a stepper motor □42

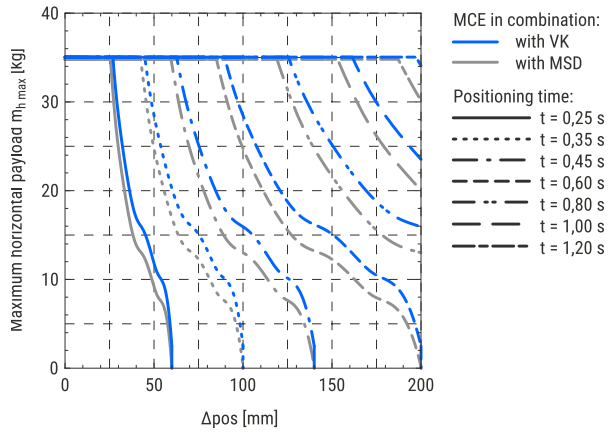

MCE 45

10 × 3 with a stepper motor □42

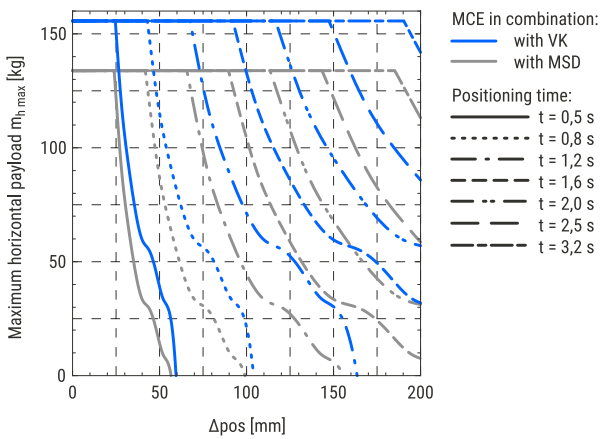

10 × 10 with a stepper motor □42

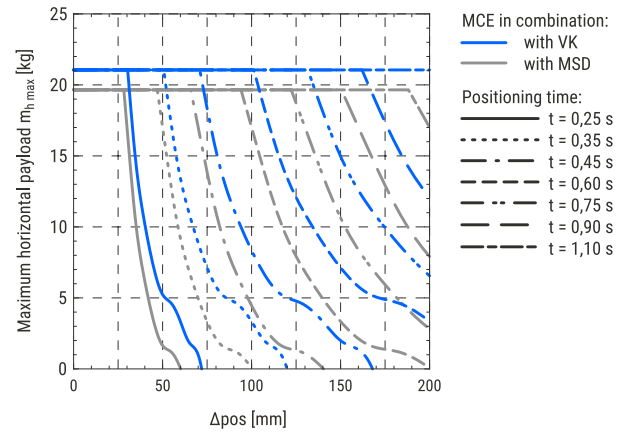

10 × 3 with a stepper motor □56

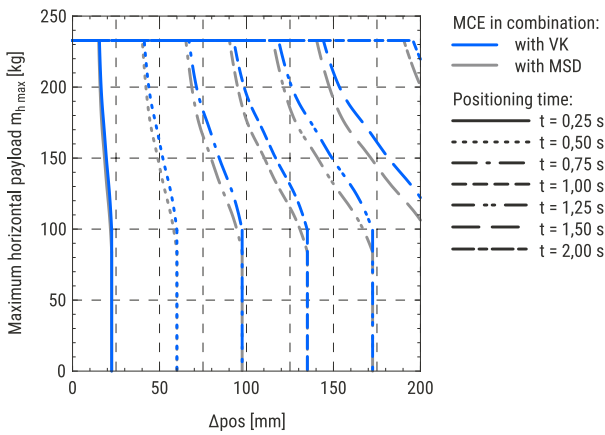

10 × 10 with a stepper motor □56

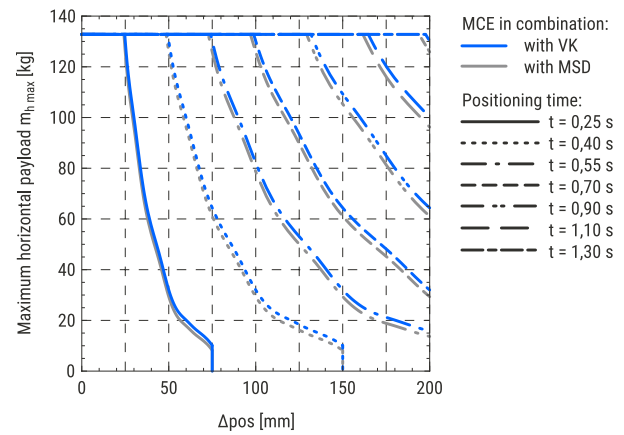

Maximum vertical payload as a function of change of the position and positioning time of the piston rod

The following diagrams show the maximum payload that can be moved by a certain vertical distance within a positioning time frame. Acceleration/deceleration time of 100 ms is taken into account.

Diagrams depend on the ball screw leads and different combinations of the standard motors. Motor adapter VK and a motor side drive MSD are also considered.

For the case where a guiding unit GUC is used, the value obtained from the diagram should be decreased by the moving mass of the guiding unit (please refer to the Guiding unit section).

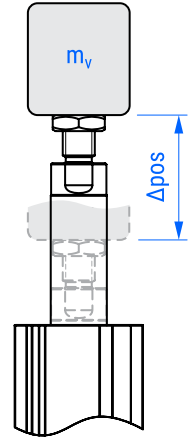

MCE 25

6 × 2 with a stepper motor □28

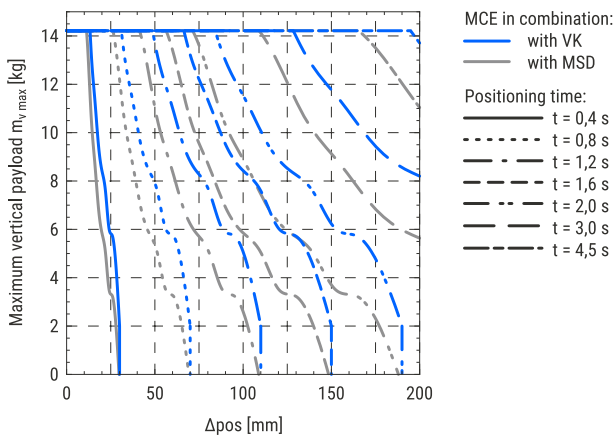

6 × 6 with a stepper motor □28

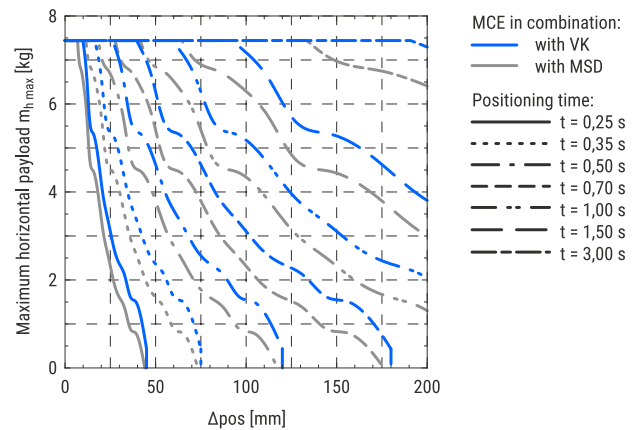

MCE 32

8 × 2 with a stepper motor □28

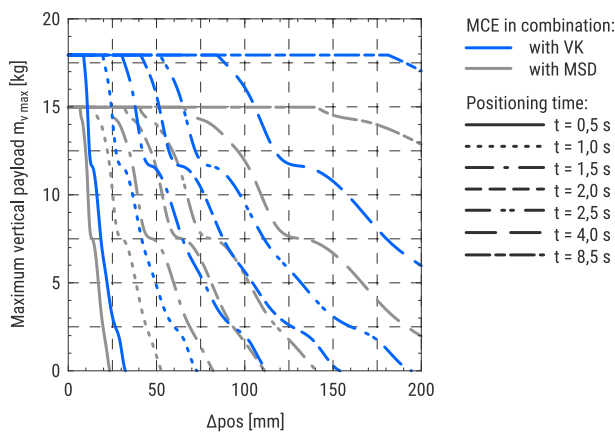

8 × 8 with a stepper motor □28

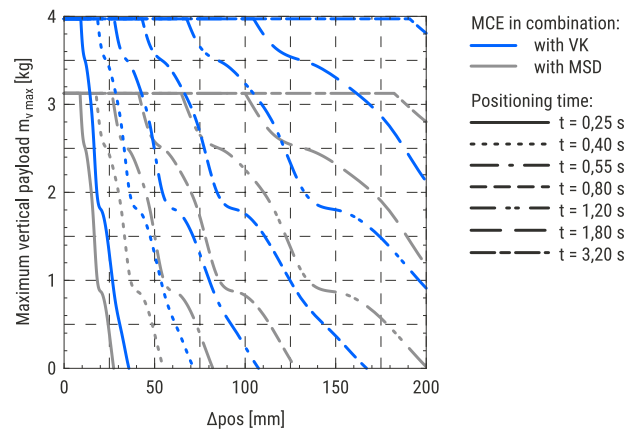

8 × 2 with a stepper motor □42

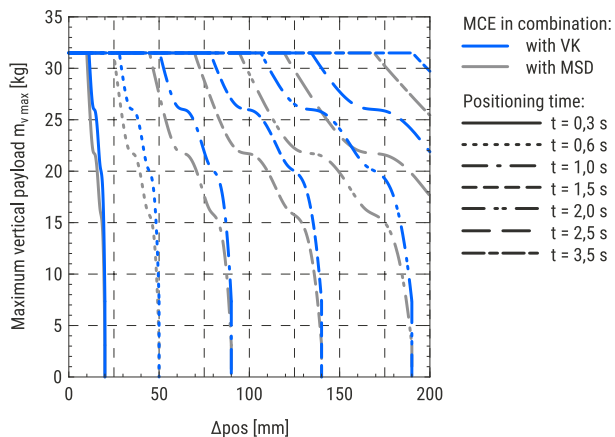

8 × 8 with a stepper motor □42

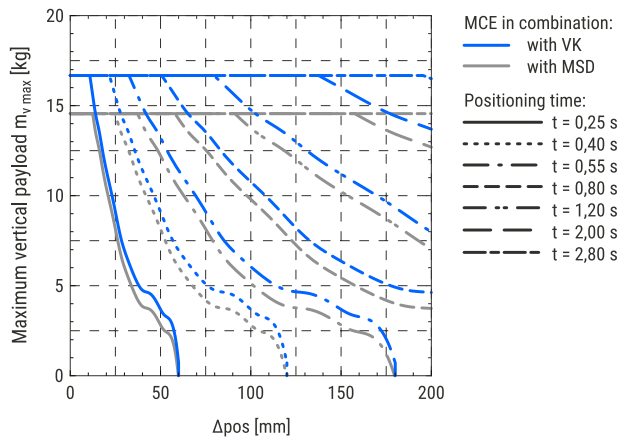

MCE 45

10 × 3 with a stepper motor □42

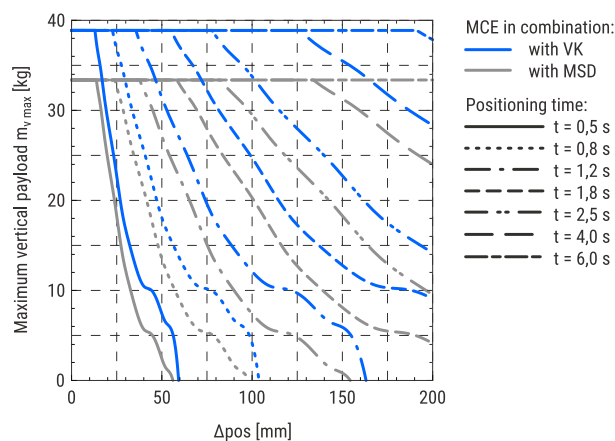

10 × 10 with a stepper motor □42

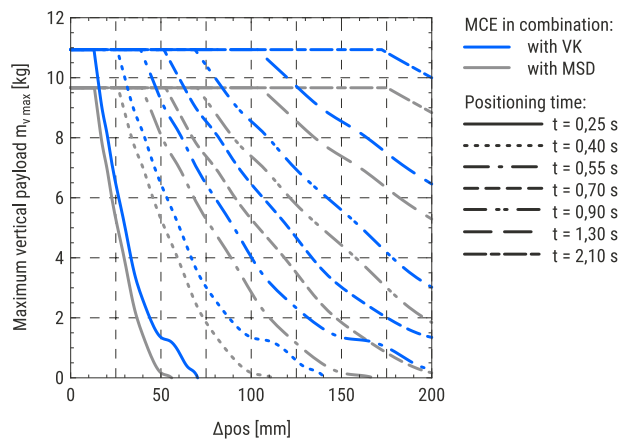

10 × 3 with a stepper motor □56

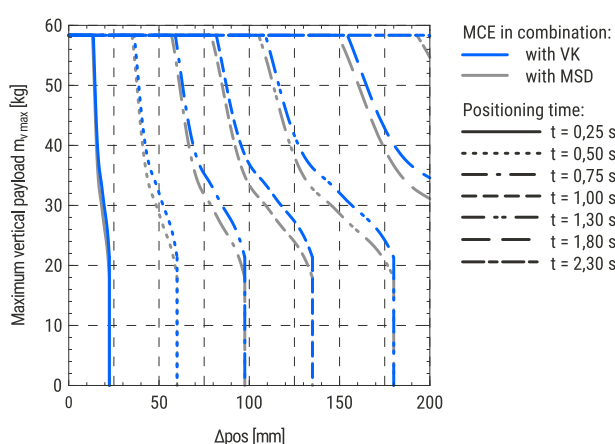

10 × 10 with a stepper motor □56

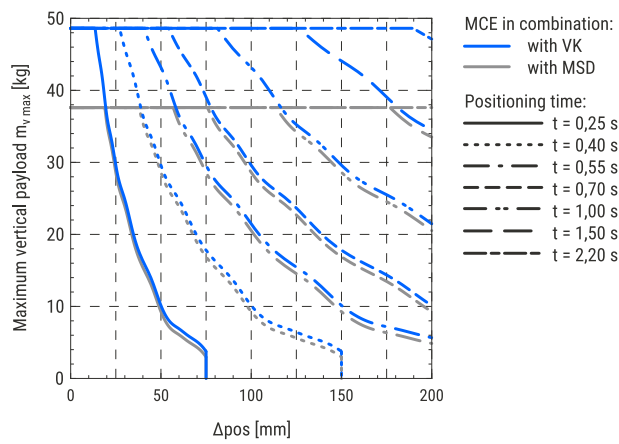

Absolute stroke and length of the MCE definition

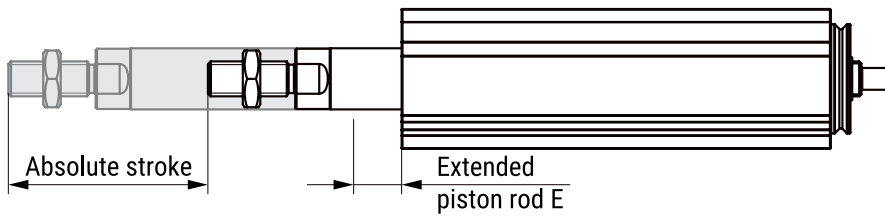

Absolute stroke definition

Absolute stroke = Effective stroke + 2 × Safety stroke

The electric cylinder MCE does not include any safety stroke.

Length definition

$L_t = L + L_2 + E + \text{Abs. position}$

Female thread:

$L_t = L + L_4 + E + \text{Abs. position}$

Abs. stroke	Absolute stroke [mm]
Abs. position	Absolute position [mm]
E	Extended piston rod [mm]
L	Length [mm]
L_t	Total length [mm]

$E_{\text{max}} = 100 \text{ mm.}$

Mini electric slider MSCE

Operating conditions

Ambient temperature	0 °C ~ +50 °C
Ambient temperature without a motor	0 °C ~ +60 °C
Protection class	IP40
Duty cycle	100 %
Maintenance	Life-time pre-lubricated

Maximum lateral loading as a function of the slide absolute position

On the following diagrams, the maximum lateral loads acting on the front plate as a function of the slide absolute position are presented. Both lateral loads in y and z directions are considered.

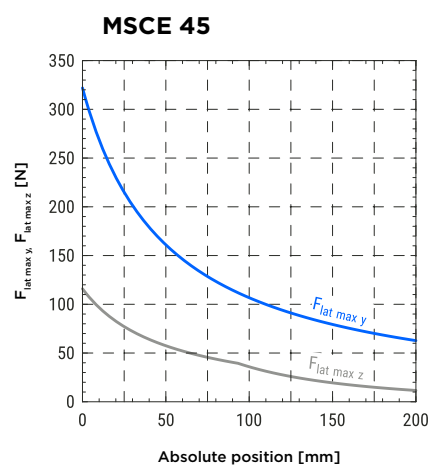
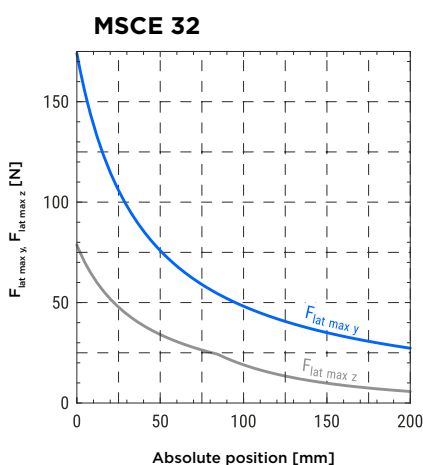
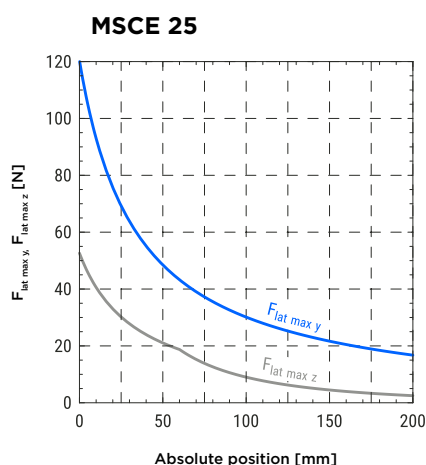
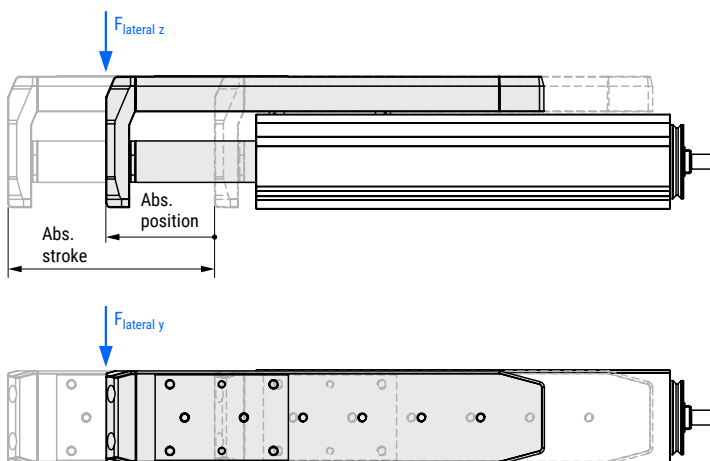

Angular deflections of the front plate as a function of the slide's absolute position

On the following diagrams, angular deflections of the front plate subjected to the different torsional moments at different absolute positions of the slide are presented. Values on the curves represent the moment about the x-axis applied to the front plate.

The maximum permissible angular deflection φ_{max} must not be exceeded.

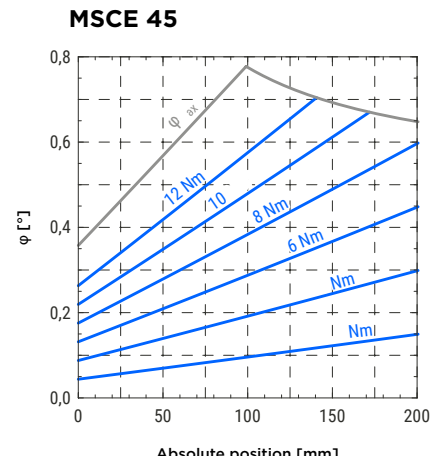
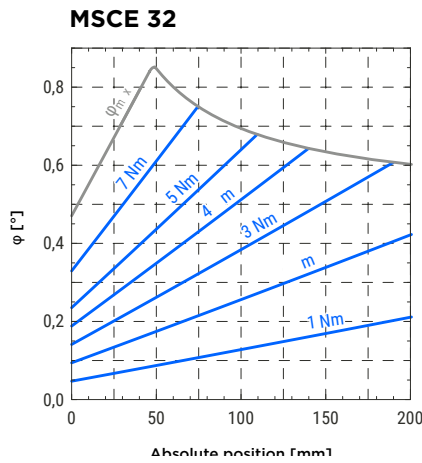
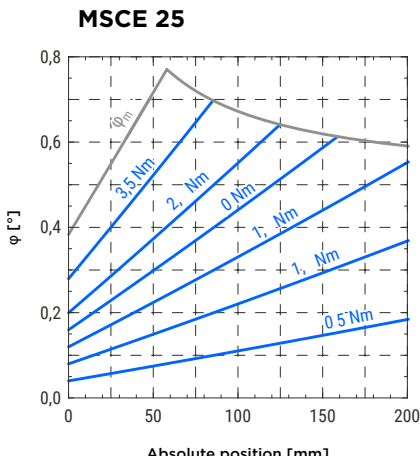
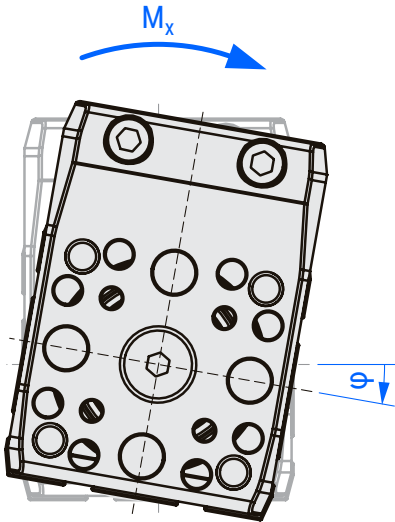

Deflections of the front plate as a function of the slide's absolute position

On the following diagrams, deflections of the front plate subjected to the different lateral loads at different absolute positions of the slide are presented. Both lateral loads in y and z directions are considered. Values on the curves represent the lateral load applied to the front plate.

The maximum permissible deflection ($\delta_{z \max}$ or $\delta_{y \max}$) must not be exceeded.

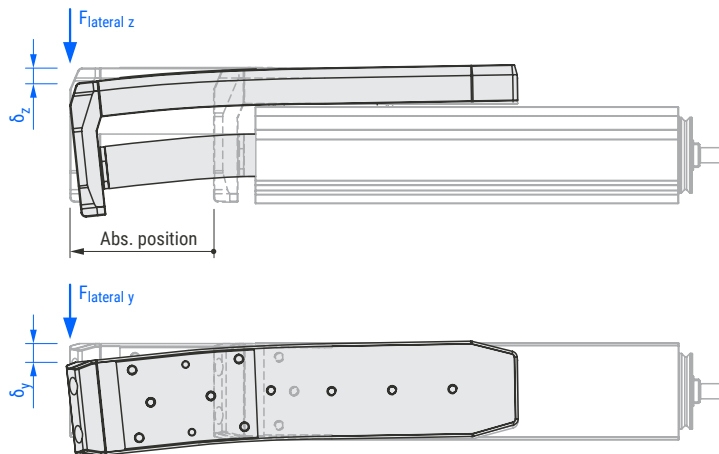

MSCE 25

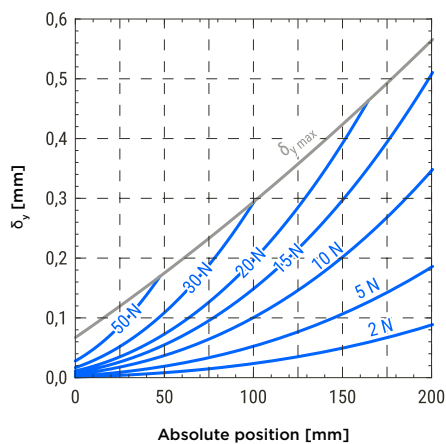
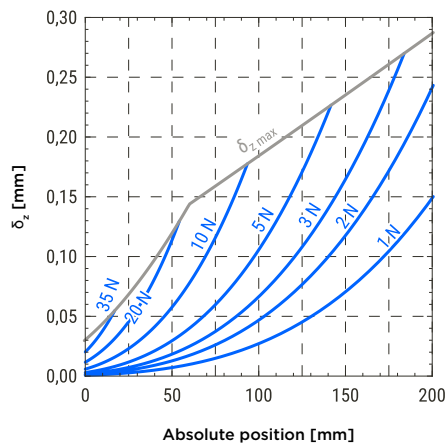

MSCE 32

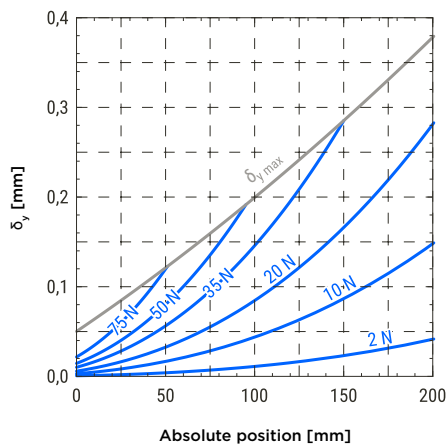
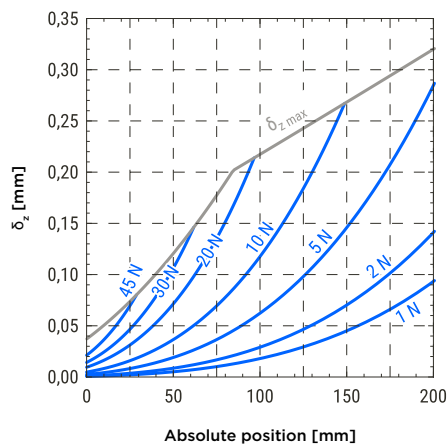

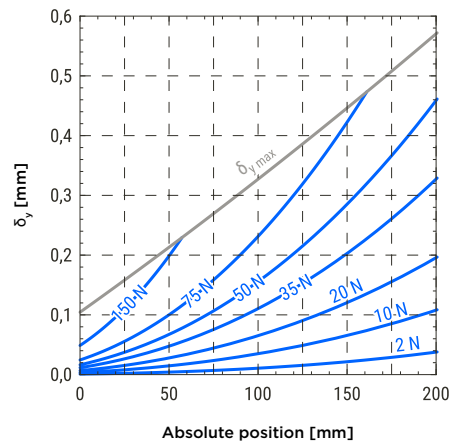
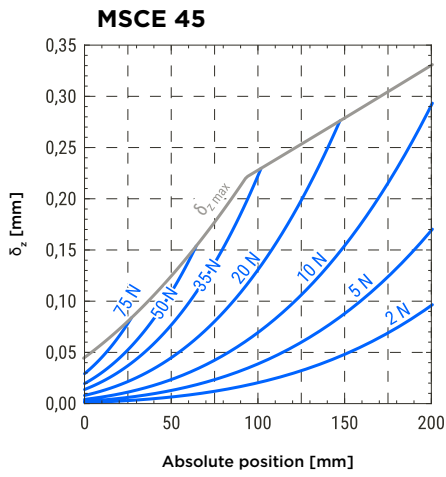

Maximum horizontal payload as a function of the travel speed and acceleration of the front plate

On the following diagrams, the maximum horizontal payloads applied to the front plate as a function of the travel speed for different accelerations, different ball screw leads, and different combinations of the standard motors are presented. Motor adapter VK and a motor side drive MSD are also considered.

Curves are valid for the payload to be pushed and supported by an external guiding (coefficient of friction 0,1 is taken into consideration).

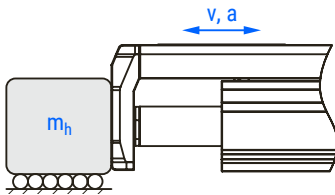

MSCE 25

6 × 2 with a stepper motor □28

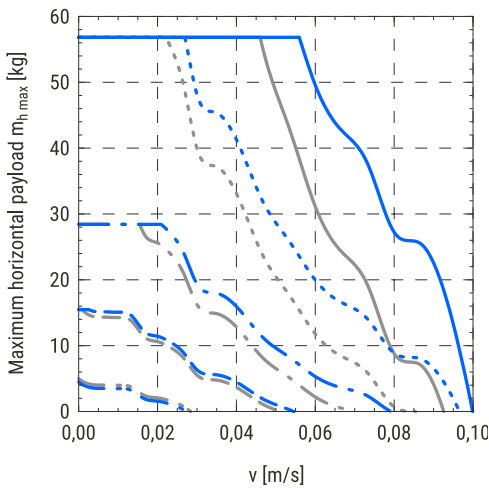

6 × 6 with a stepper motor □28

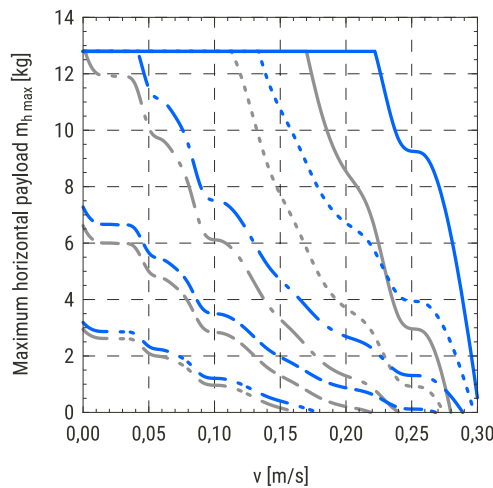

- MSCE in combination:
- with VK
 - with MSD
- Acceleration/Deceleration:
- a = 0,5 m/s²
 - - - a = 2 m/s²
 - · - a = 5 m/s²
 - - - a = 10 m/s²
 - · - a = 20 m/s²

MSCE 32

8 × 2 with a stepper motor □28

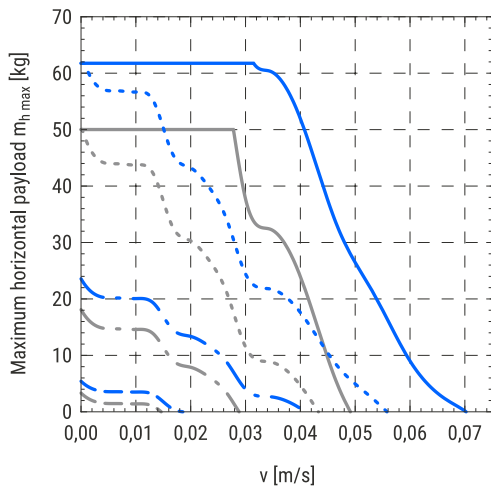

8 × 8 with a stepper motor □28

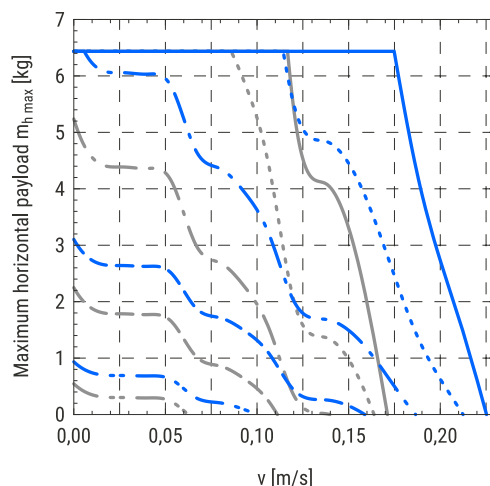

- MSCE in combination:
- with VK
 - with MSD
- Acceleration/Deceleration:
- a = 0,5 m/s²
 - - - a = 2 m/s²
 - · - a = 5 m/s²
 - - - a = 10 m/s²
 - · - a = 20 m/s²

8 × 2 with a stepper motor □42

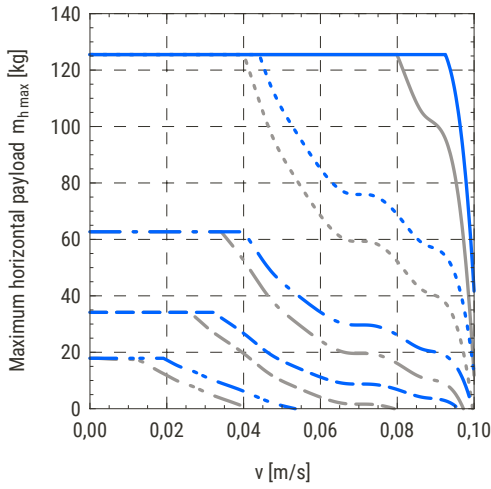

8 × 8 with a stepper motor □42

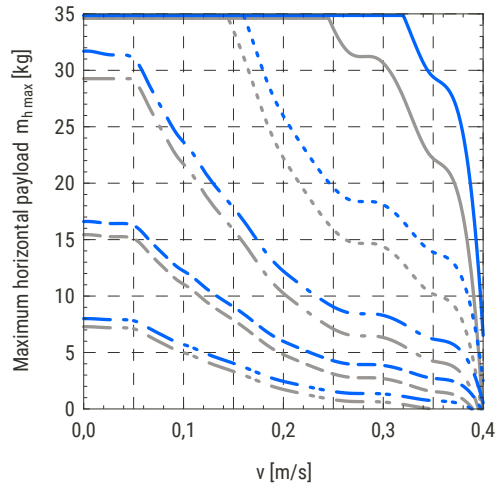

MSCE in combination:
 — with VK
 — with MSD

Acceleration/Deceleration:
 — $a = 0,5 \text{ m/s}^2$
 - - - $a = 2 \text{ m/s}^2$
 - · - $a = 5 \text{ m/s}^2$
 - - - $a = 10 \text{ m/s}^2$
 - · - $a = 20 \text{ m/s}^2$

MSCE 45

10 × 3 with a stepper motor □42

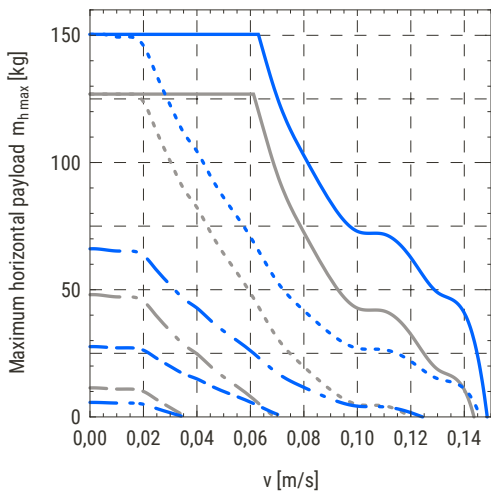

10 × 10 with a stepper motor □42

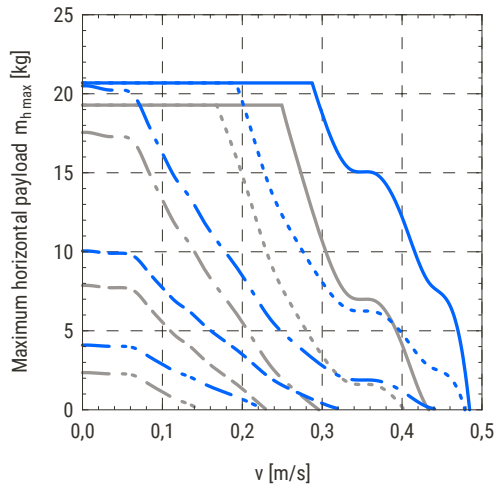

MSCE in combination:
 — with VK
 — with MSD

Acceleration/Deceleration:
 — $a = 0,5 \text{ m/s}^2$
 - - - $a = 2 \text{ m/s}^2$
 - · - $a = 5 \text{ m/s}^2$
 - - - $a = 10 \text{ m/s}^2$
 - · - $a = 20 \text{ m/s}^2$

10 × 3 with a stepper motor □56

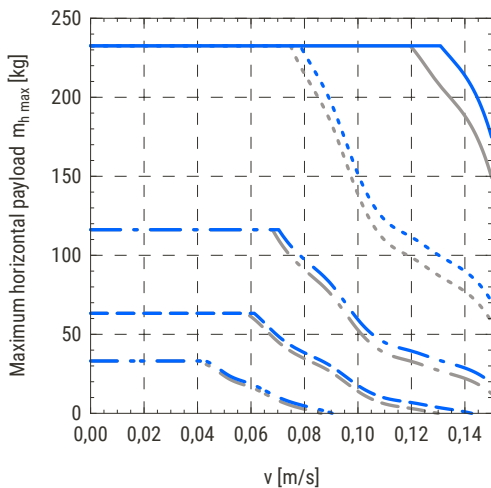

10 × 10 with a stepper motor □56

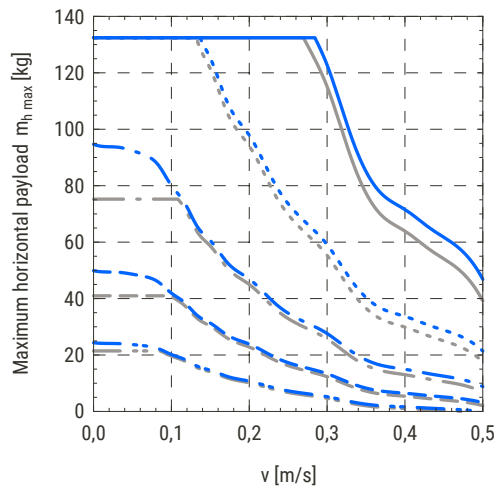

MSCE in combination:
 — with VK
 — with MSD

Acceleration/Deceleration:
 — $a = 0,5 \text{ m/s}^2$
 - - - $a = 2 \text{ m/s}^2$
 - · - $a = 5 \text{ m/s}^2$
 - - - $a = 10 \text{ m/s}^2$
 - · - $a = 20 \text{ m/s}^2$

Maximum vertical payload as a function of the travel speed and acceleration of the front plate

On the following diagrams, the maximum vertical payloads applied to the front plate as a function of the travel speed for different accelerations, different ball screw leads, and different combinations of the standard motors are presented. Motor adapter VK and a motor side drive MSD are also considered.

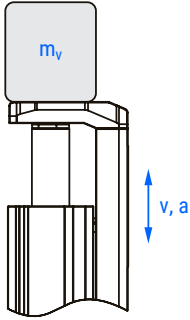

MSCE 25

6 × 2 with a stepper motor □28

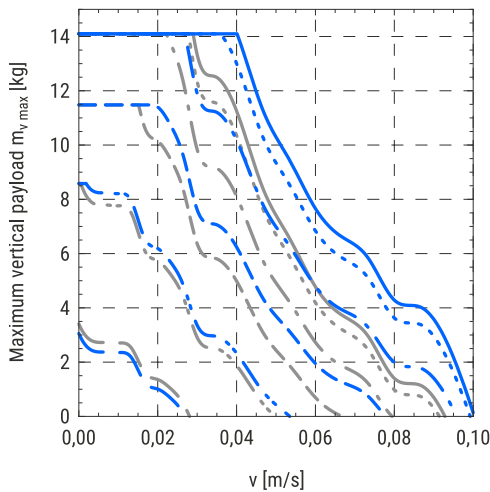

6 × 6 with a stepper motor □28

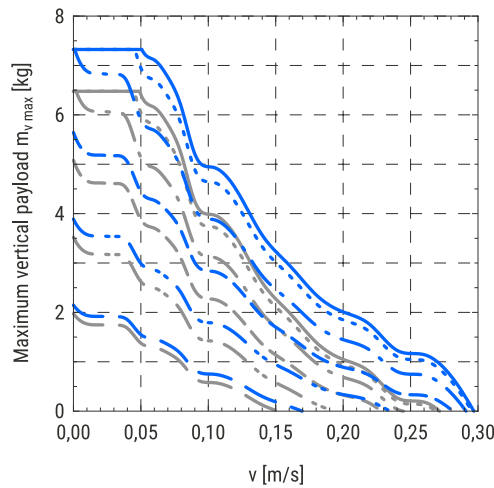

MSCE in combination:

- with VK
- - - with MSD

Acceleration/Deceleration:

- a = 0 m/s²
- - - a = 0,5 m/s²
- · - a = 2 m/s²
- - - a = 5 m/s²
- · - a = 10 m/s²
- - - a = 20 m/s²

MSCE 32

8 × 2 with a stepper motor □28

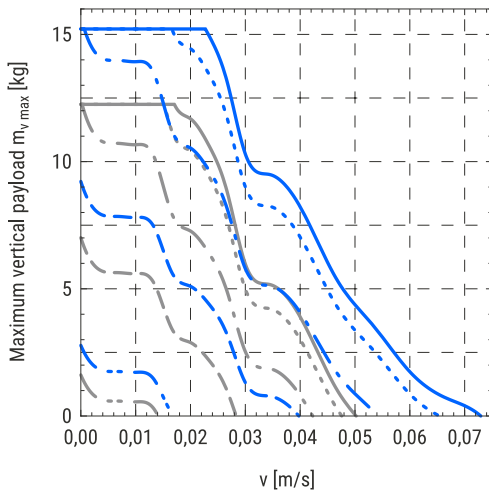

8 × 8 with a stepper motor □28

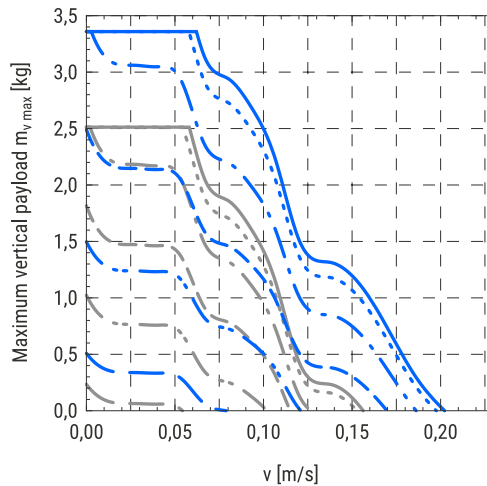

MSCE in combination:

- with VK
- - - with MSD

Acceleration/Deceleration:

- a = 0 m/s²
- - - a = 0,5 m/s²
- · - a = 2 m/s²
- - - a = 5 m/s²
- · - a = 10 m/s²
- - - a = 20 m/s²

8 × 2 with a stepper motor □42

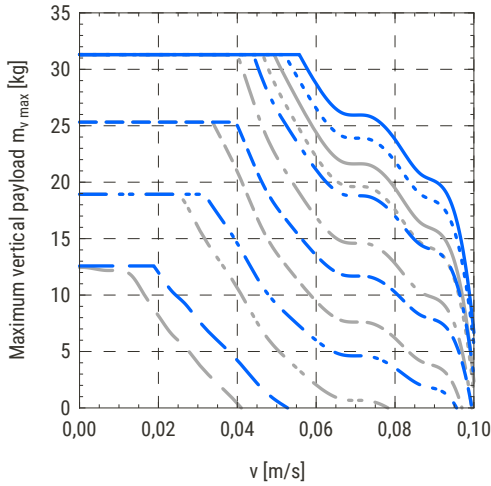

8 × 8 with a stepper motor □42

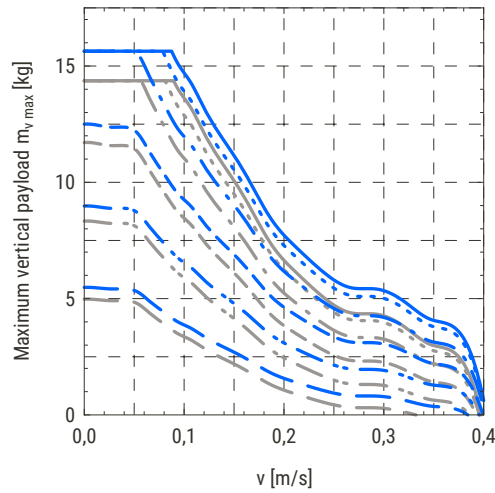

MSCE in combination:
 — with VK
 — with MSD

Acceleration/Deceleration:
 — $a = 0 \text{ m/s}^2$
 - - - $a = 0,5 \text{ m/s}^2$
 - · - $a = 2 \text{ m/s}^2$
 - - - $a = 5 \text{ m/s}^2$
 - · - $a = 10 \text{ m/s}^2$
 — $a = 20 \text{ m/s}^2$

MSCE 45

10 × 3 with a stepper motor □42

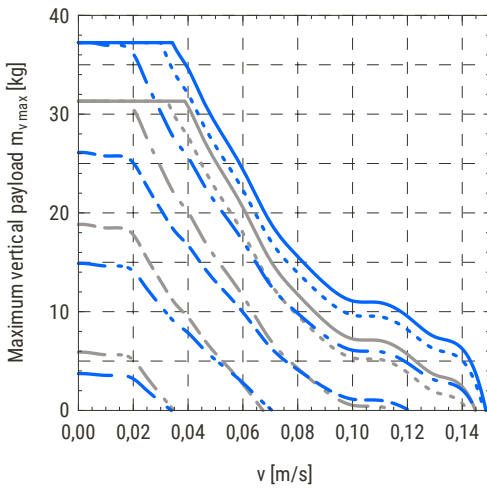

10 × 10 with a stepper motor □42

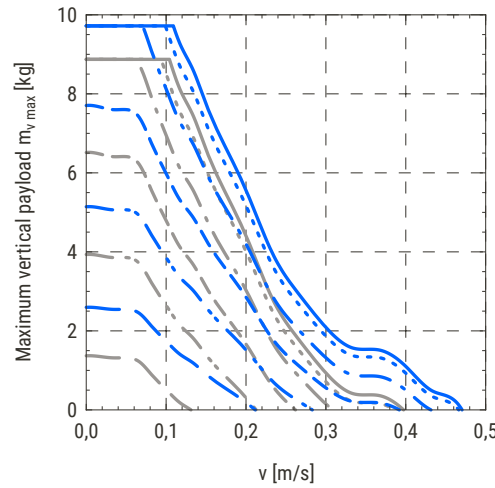

MSCE in combination:
 — with VK
 — with MSD

Acceleration/Deceleration:
 — $a = 0 \text{ m/s}^2$
 - - - $a = 0,5 \text{ m/s}^2$
 - · - $a = 2 \text{ m/s}^2$
 - - - $a = 5 \text{ m/s}^2$
 - · - $a = 10 \text{ m/s}^2$
 — $a = 20 \text{ m/s}^2$

10 × 3 with a stepper motor □56

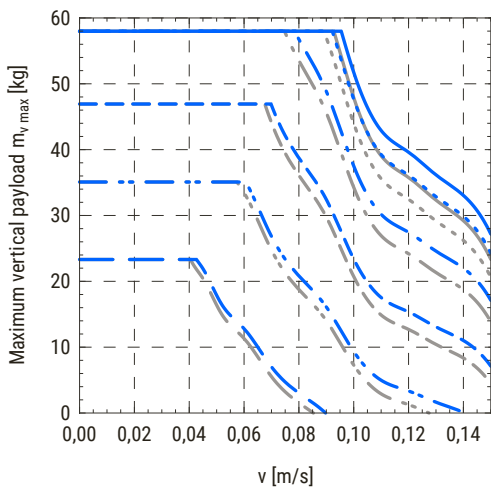

10 × 10 with a stepper motor □56

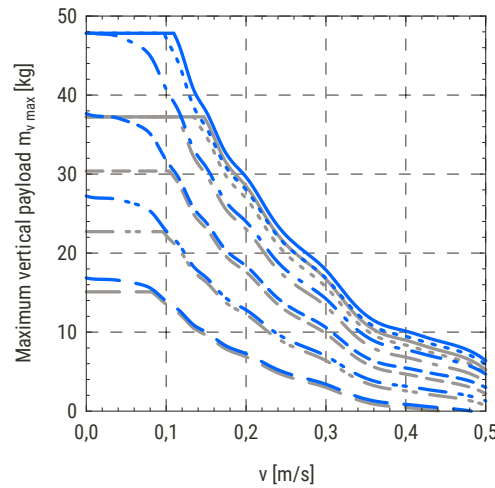

MSCE in combination:
 — with VK
 — with MSD

Acceleration/Deceleration:
 — $a = 0 \text{ m/s}^2$
 - - - $a = 0,5 \text{ m/s}^2$
 - · - $a = 2 \text{ m/s}^2$
 - - - $a = 5 \text{ m/s}^2$
 - · - $a = 10 \text{ m/s}^2$
 — $a = 20 \text{ m/s}^2$

Maximum axial load as a function of the travel speed and acceleration of the front plate

On the following diagrams, the maximum axial load applied to the front plate as a function of the travel speed for different accelerations, different ball screw leads and different combinations of the standard motors is presented. Motor adapter VK and a motor side drive MSD are also considered.

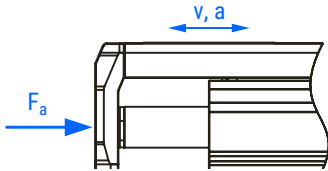

MSCE 25

6 × 2 with a stepper motor □28

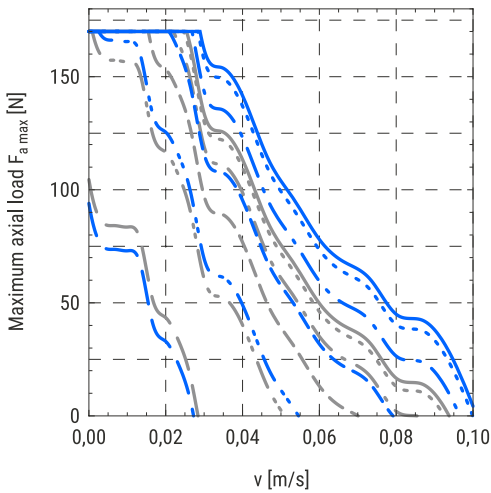

6 × 6 with a stepper motor □28

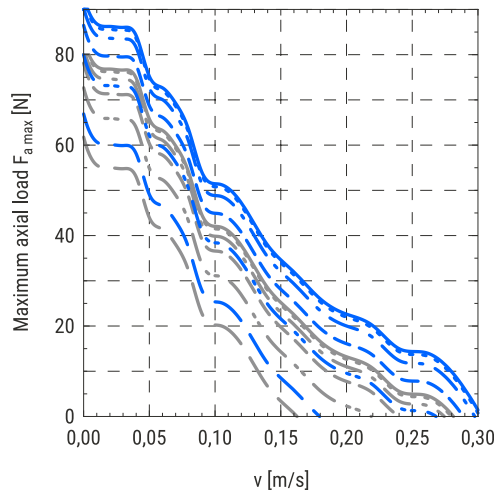

- MSCE in combination:
- with VK
 - - - with MSD
- Acceleration/Deceleration:
- a = 0 m/s²
 - - - a = 0,5 m/s²
 - · - a = 2 m/s²
 - - - a = 5 m/s²
 - · - a = 10 m/s²
 - - - a = 20 m/s²

MSCE 32

8 × 2 with a stepper motor □28

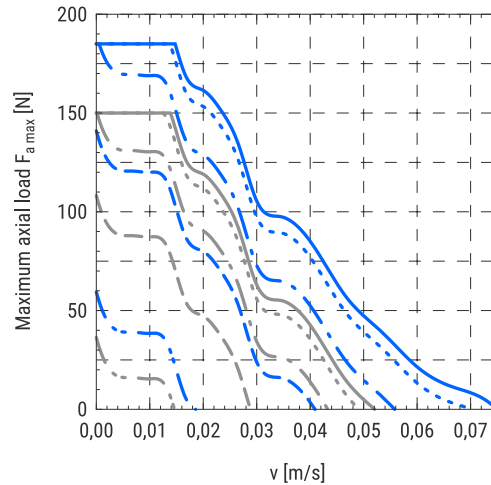

8 × 8 with a stepper motor □28

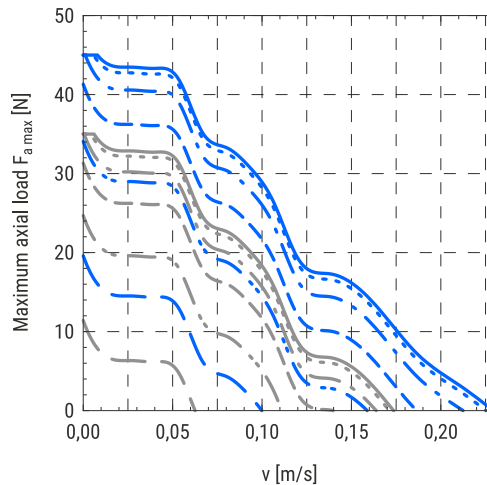

- MSCE in combination:
- with VK
 - - - with MSD
- Acceleration/Deceleration:
- a = 0 m/s²
 - - - a = 0,5 m/s²
 - · - a = 2 m/s²
 - - - a = 5 m/s²
 - · - a = 10 m/s²
 - - - a = 20 m/s²

8 × 2 with a stepper motor □42

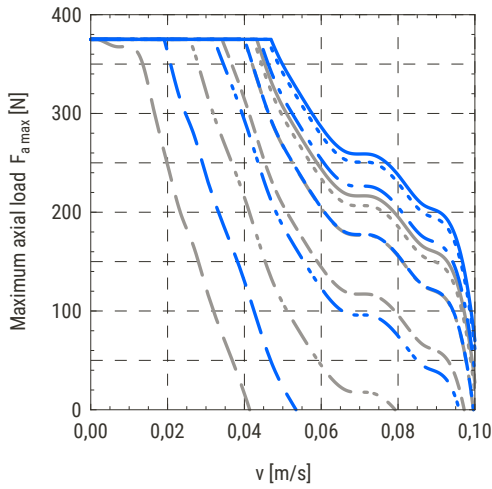

8 × 8 with a stepper motor □42

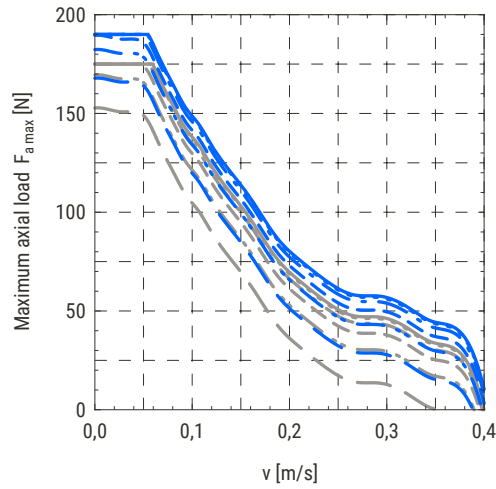

MSCE in combination:
 — with VK
 — with MSD

Acceleration/Deceleration:
 — $a = 0 \text{ m/s}^2$
 - - - $a = 0,5 \text{ m/s}^2$
 - · - $a = 2 \text{ m/s}^2$
 - - - $a = 5 \text{ m/s}^2$
 - · - $a = 10 \text{ m/s}^2$
 - - - $a = 20 \text{ m/s}^2$

MSCE 45

10 × 3 with a stepper motor □42

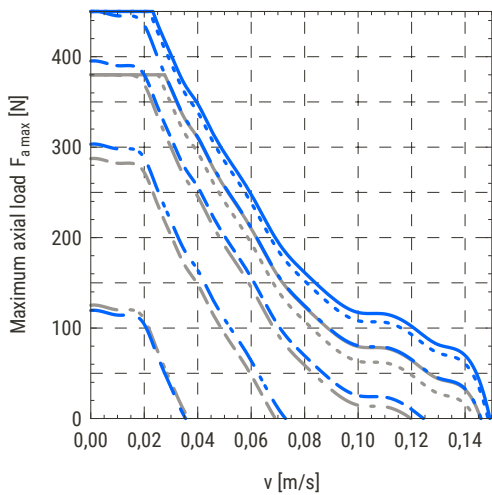

10 × 10 with a stepper motor □42

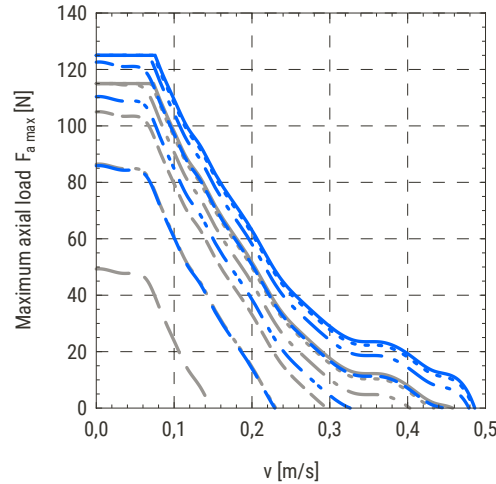

MSCE in combination:
 — with VK
 — with MSD

Acceleration/Deceleration:
 — $a = 0 \text{ m/s}^2$
 - - - $a = 0,5 \text{ m/s}^2$
 - · - $a = 2 \text{ m/s}^2$
 - - - $a = 5 \text{ m/s}^2$
 - · - $a = 10 \text{ m/s}^2$
 - - - $a = 20 \text{ m/s}^2$

10 × 3 with a stepper motor □56

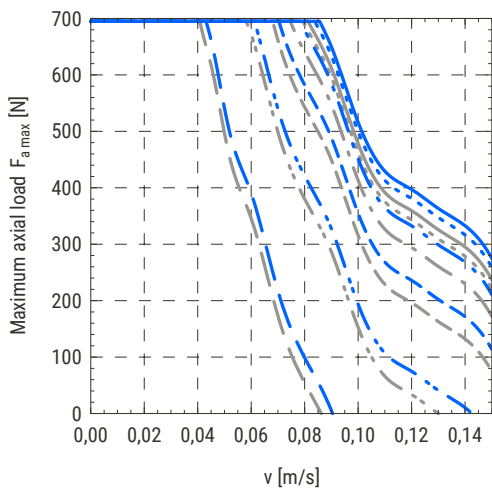

10 × 10 with a stepper motor □56

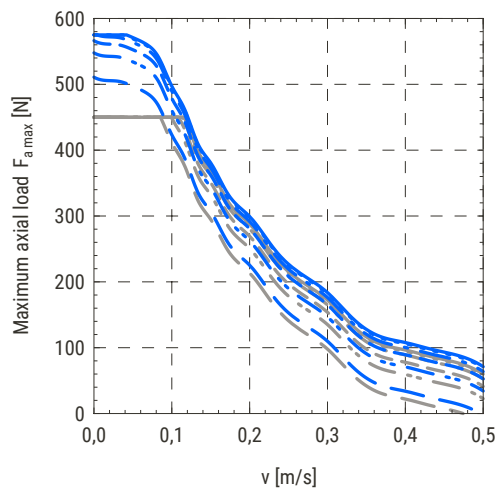

MSCE in combination:
 — with VK
 — with MSD

Acceleration/Deceleration:
 — $a = 0 \text{ m/s}^2$
 - - - $a = 0,5 \text{ m/s}^2$
 - · - $a = 2 \text{ m/s}^2$
 - - - $a = 5 \text{ m/s}^2$
 - · - $a = 10 \text{ m/s}^2$
 - - - $a = 20 \text{ m/s}^2$

Maximum horizontal payload as a function of change of the position and positioning time of the front plate

The following diagrams show the maximum payload that can be moved by a certain horizontal distance within a positioning time frame. Acceleration/deceleration time of 100 ms is taken into account.

Diagrams depend on the ball screw leads and different combinations of the standard motors. Motor adapter VK and a motor side drive MSD are also considered.

Curves are valid for the payload to be pushed and supported by an external guiding (coefficient of friction 0,1 is taken into consideration).

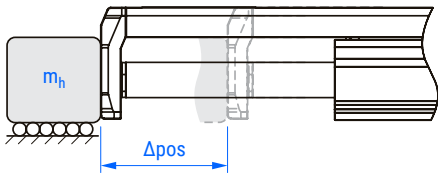

MSCE 25

6 × 2 with a stepper motor □28

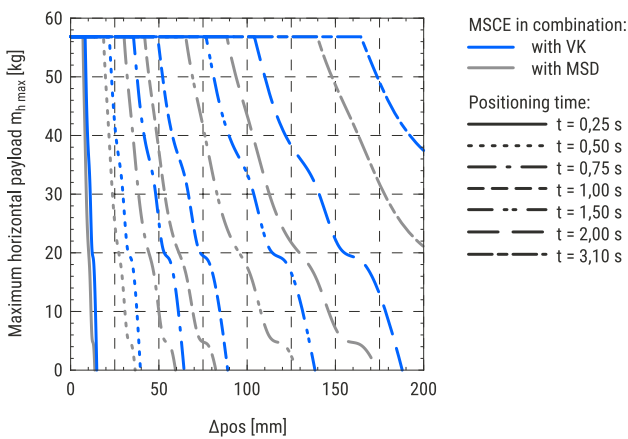

6 × 6 with a stepper motor □28

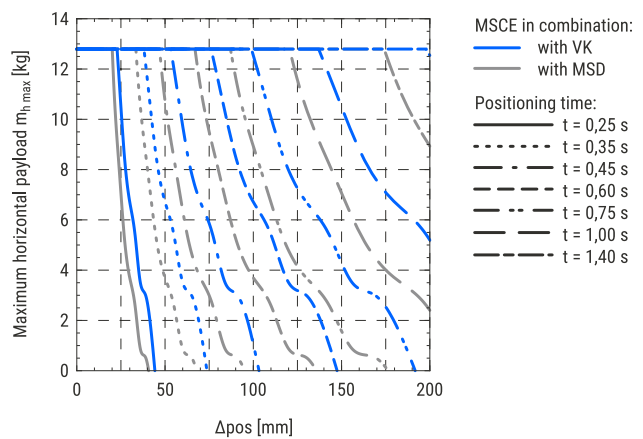

MSCE 32

8 × 2 with a stepper motor □28

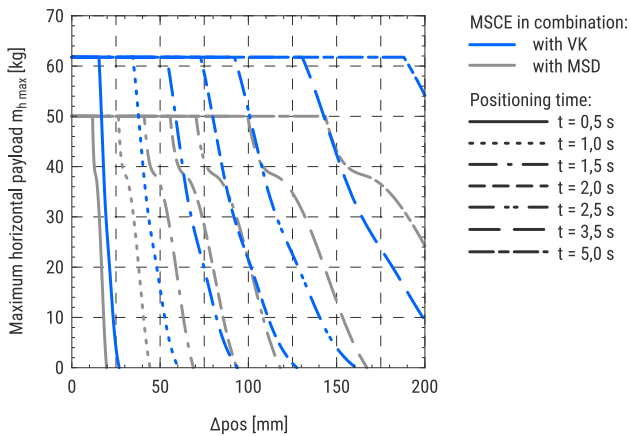

8 × 8 with a stepper motor □28

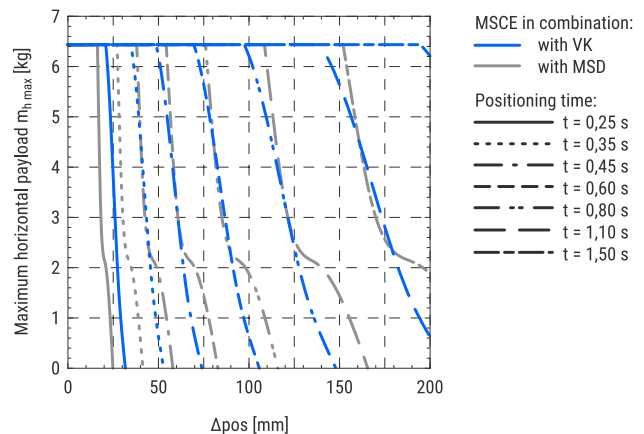

8 × 2 with a stepper motor □42

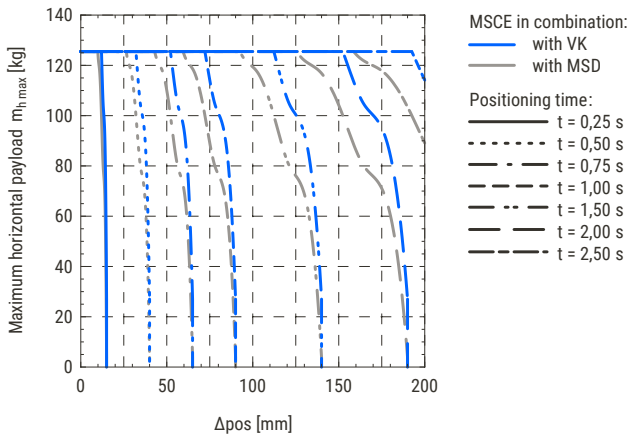

8 × 8 with a stepper motor □42

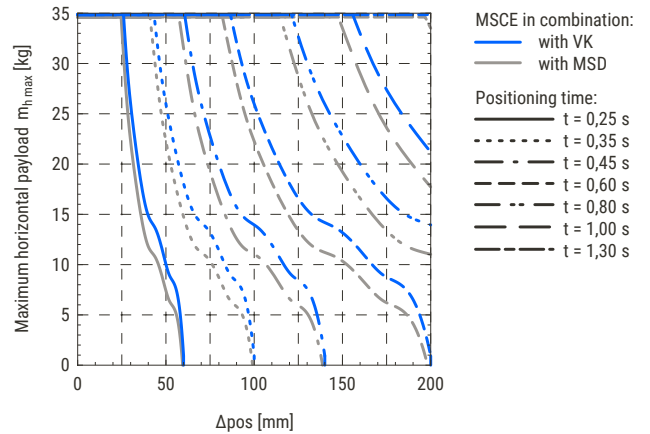

MSCE 45

10 × 3 with a stepper motor □42

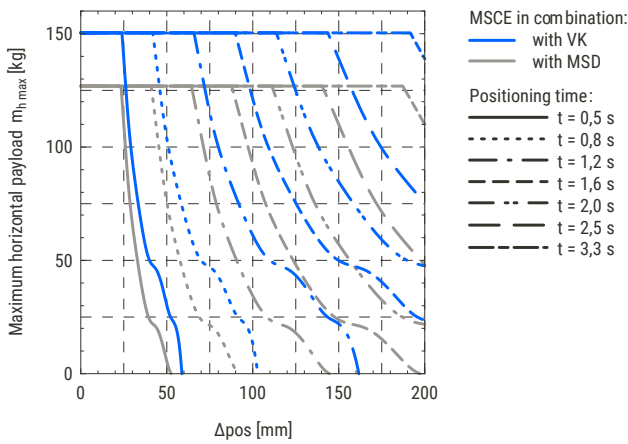

10 × 10 with a stepper motor □42

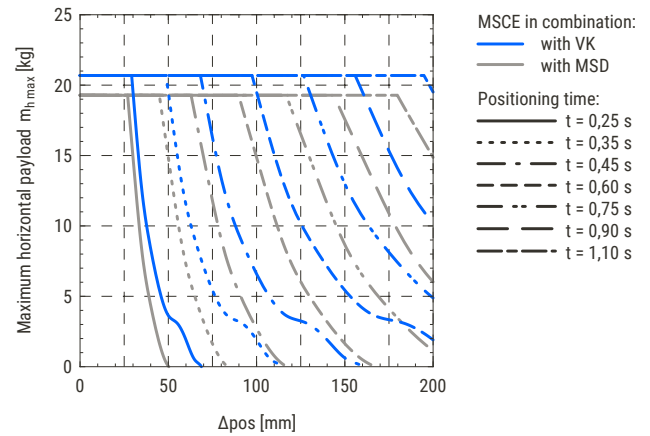

10 × 3 with a stepper motor □56

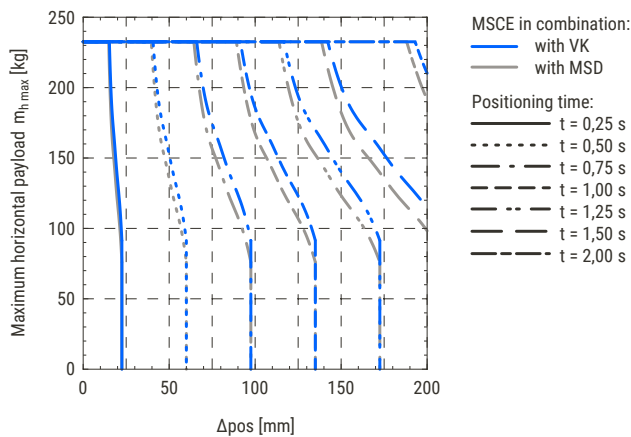

10 × 10 with a stepper motor □56

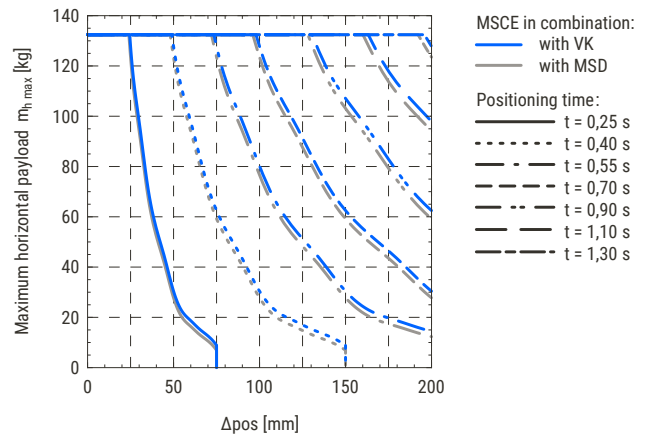

Maximum vertical payload as a function of change of the position and positioning time of the front plate

The following diagrams show the maximum payload that can be moved by a certain vertical distance within a positioning time frame. Acceleration/deceleration time of 100 ms is taken into account.

Diagrams depend on the ball screw leads and different combinations of the standard motors. Motor adapter VK and a motor side drive MSD are also considered.

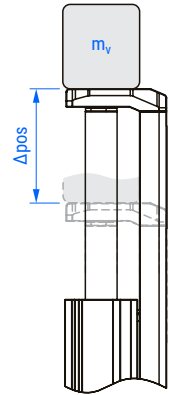

MSCE 25

6 × 2 with a stepper motor □28

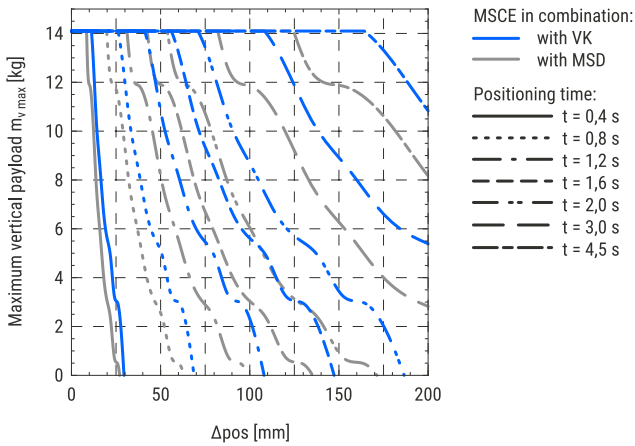

6 × 6 with a stepper motor □28

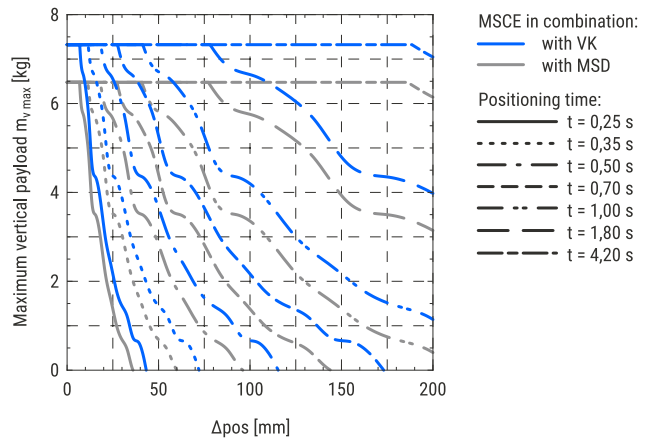

MSCE 32

8 × 2 with a stepper motor □28

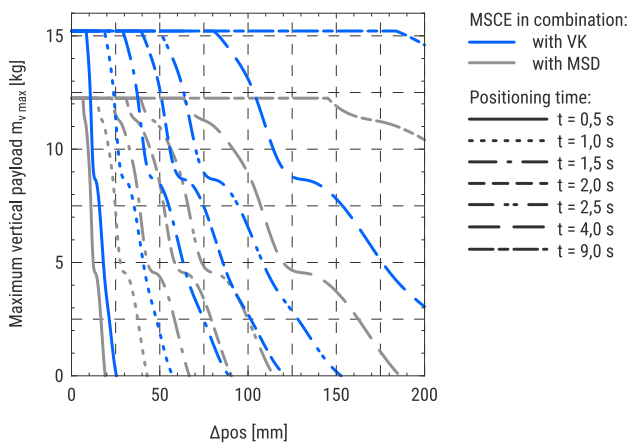

8 × 8 with a stepper motor □28

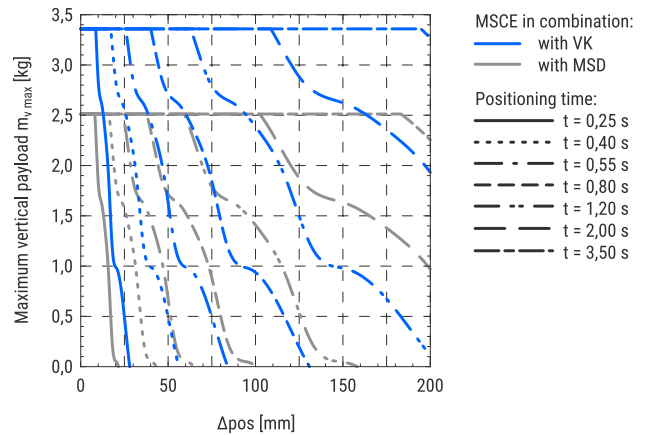

8 × 2 with a stepper motor □42

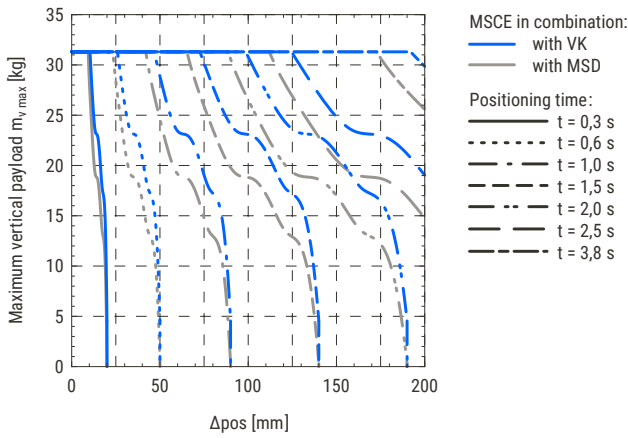

8 × 8 with a stepper motor □42

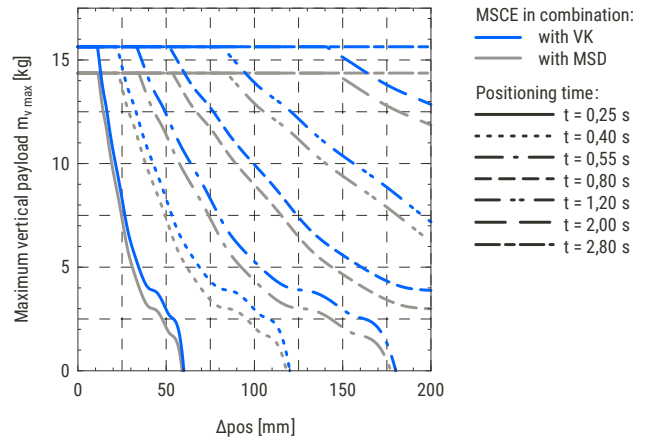

MSCE 45

10 × 3 with a stepper motor □42

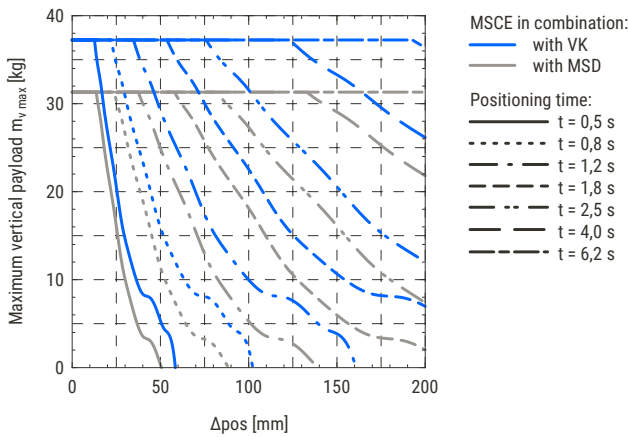

10 × 10 with a stepper motor □42

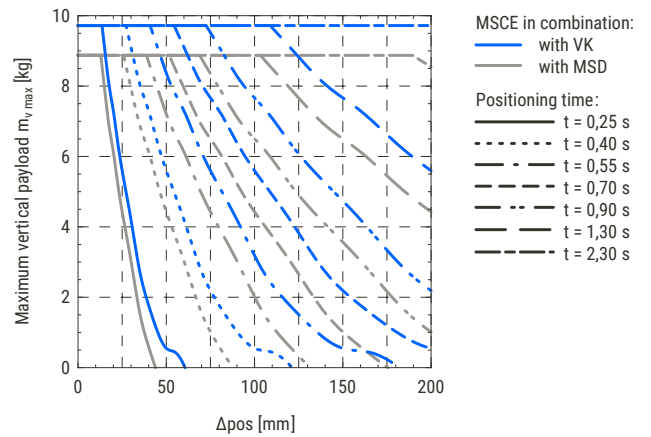

10 × 3 with a stepper motor □56

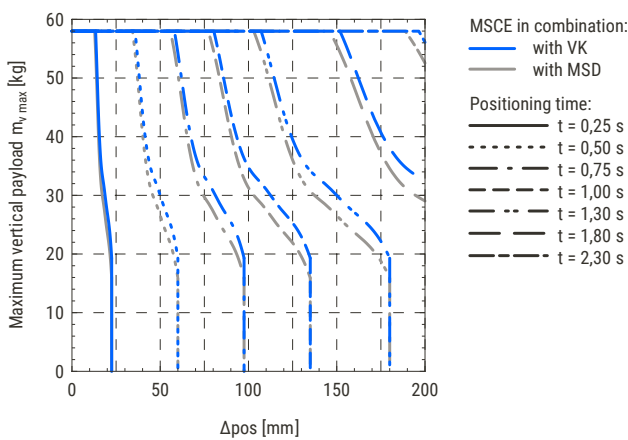

10 × 10 with a stepper motor □56

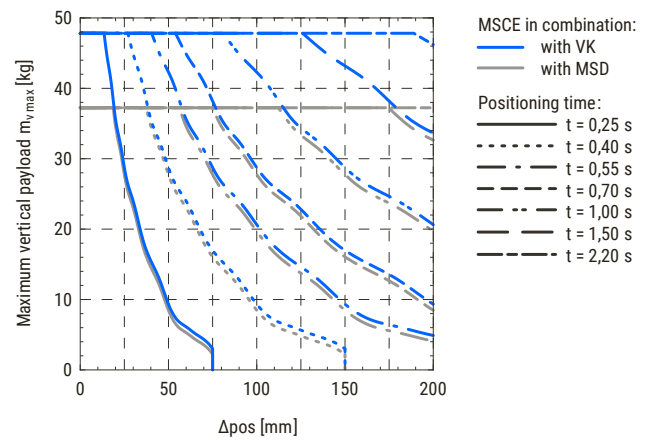

Absolute stroke and length of the MSCE definition

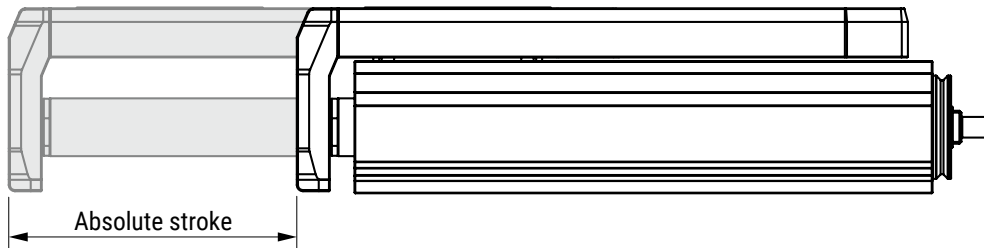

Absolute stroke definition

Absolute stroke = Effective stroke + 2 × Safety stroke

The electric slider MSCE does not include any safety stroke.

Length definition

$L_t = L + L_2 + \text{Abs. position}$

Length L and L_t are defined as it is presented on the dimensional drawings above, where lengths of a motor, motor adapter VK, and motor side drive MSD are also considered.

Abs. stroke	Absolute stroke [mm]
Abs. position	Absolute position [mm]
L	Length [mm]
L_t	Total length [mm]

Motor types and sizes

Motor identification

Designation	Type	Motor	
		Size □ [mm]	Brake
STMN-28-L-E*	Stepper	28	-
STMN-28-L-E-B*	Stepper	28	with
STMN-42-L-E	Stepper	42	-
STMN-42-L-E-B	Stepper	42	with
STMN-56-L-E	Stepper	56	-
STMN-56-L-E-B	Stepper	56	with

*Available soon.

□ = Square cross section

Motor pin allocation

Valid for stepper motor size of 42 and 56 mm. Stepper motor size of 28 mm is available soon.

Motor connector

Connector type: M12 5-pole

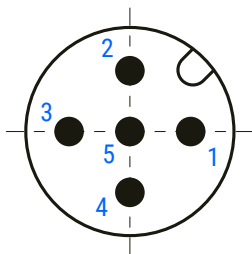

Pin	Function
1	A-
2	A+
3	B+
4	B-
5	Housing

Encoder connector

Connector type: M12 8-pole

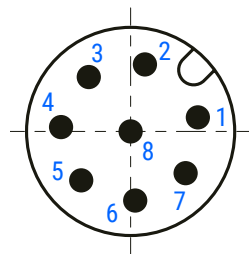

Pin	Function
1	A-
2	A+
3	B+
4	B-
5	GND
6	I-
7	I+
8	VCC (5 V)
Housing	GND/shielding

Brake connector

Connector type: M8 3-pole

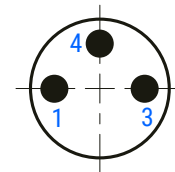

Valid only for motors with a brake.

Pin	Function
1	Brake +24V
3	Brake/GND
4	NC

Technical data

Motor

Designation	Voltage [V DC]	Current per phase [A]	Mass moment of inertia [kg cm ²]	Holding torque [Nm]	Step angle [°]
STMN-28-L-E	Available soon				
STMN-28-L-E-B	Available soon				
STMN-42-L-E	3,15	1,8	0,082	0,5	1,8 ± 5 %
STMN-42-L-E-B	3,15	1,8	0,095	0,5	1,8 ± 5 %
STMN-56-L-E	2,4	4,2	0,480	1,87	1,8 ± 5 %
STMN-56-L-E-B	2,4	4,2	0,501	1,87	1,8 ± 5 %

Designation	Resistance per phase [Ohm]	Inductance per phase [mH]	Voltage constant [mV/min ⁻¹]	Mass [kg]
STMN-28-L-E	Available soon			
STMN-28-L-E-B	Available soon			
STMN-42-L-E	1,75 ± 10 %	3,3 ± 20 %	23	0,44
STMN-42-L-E-B	1,75 ± 10 %	3,3 ± 20 %	23	0,57
STMN-56-L-E	0,58 ± 15 %	1,9 ± 20 %	32,5	1,14
STMN-56-L-E-B	0,58 ± 15 %	1,9 ± 20 %	32,5	1,33

Encoder

Designation	Type	Measuring principle	Interface	Resolution [cpr/ppr]	Operating voltage [V DC]
STMN-28-L-...	Available soon				
STMN-42-L-...	Incremental	Opto-electrical	Line drive	500/2000	5
STMN-56-L-...	Incremental	Opto-electrical	Line drive	500/2000	5

Brake

Designation	Operating voltage [V DC]	Rated output [W]	Holding torque [Nm]	Mass moment of inertia [kg cm ²]
STMN-28-L-...	Available soon			
STMN-42-L-...	24 (+6/-10 %)	8	0,4	0,013
STMN-56-L-...	24 (+6/-10 %)	10	1,0	0,021

Operating conditions

Ambient temperature	-10 °C - +50 °C
Ambient humidity	max. 85 % (non-condensing)
Protection class*	IP65
Duty cycle	100 %

*Except the shaft output.

Drive types

Drive identification and compatibility

Designation	Drive		Compatible with
	Type	Protocol/control	
STDF-28-A-EC*	Stepper	EtherCat	STMN-28-L...
STDF-42-A-EC	Stepper	EtherCat	STMN-42-L...
STDF-56-A-EC	Stepper	EtherCat	STMN-56-L...
STDF-28-A-EN*	Stepper	Ethernet based communication	STMN-28-L...
STDF-42-A-EN	Stepper	Ethernet based communication	STMN-42-L...
STDF-56-A-EN	Stepper	Ethernet based communication	STMN-56-L...
STDF-28-A-PD*	Stepper	Pulse-direction control	STMN-28-L...
STDF-42-A-PD	Stepper	Pulse-direction control	STMN-42-L...
STDF-56-A-PD	Stepper	Pulse-direction control	STMN-56-L...

*Available soon.

Technical data

Designation	Operating voltage [V DC]	Current consumption* [mA]	Rotational speed [rpm]	Supported resolution**
				[ppr]
STDF-...-EC	24 ± 10 %	max. 500	0 ~ 3000	500, 1000, 1600, 2000, 3600, 5000, 6400, 7200, 10000
STDF-...-EN	24 ± 10 %	max. 500	0 ~ 3000	500, 1000, 1600, 2000, 3600, 5000, 6400, 7200, 10000
STDF-...-PD	24 ± 10 %	max. 500	0 ~ 3000	500, 1000, 1600, 2000, 3600, 5000, 6400, 7200, 10000

Designation	Input signals	Output signals
STDF-...-EC	3 dedicated inputs (LIMIT+, LIMIT-, ORIGIN); 7 user inputs (Photocoupler)	6 user outputs (Photocoupler); Brake
STDF-...-EN	3 dedicated inputs (LIMIT+, LIMIT-, ORIGIN); 9 Programmable inputs (Photocoupler)	1 dedicated output (Compare out); 9 programmable outputs (Photocoupler); Brake
STDF-...-PD	Position command pulse; Servo on/off; Alarm reset (Photocoupler input)	In-position; Alarm (Photocoupler output); Encoder signal, brake

*Except the motor current.

**For the case that resolution is higher than the encoder's resolution, the motor shall operate by micro-step between pulses.

Operating conditions

Ambient temperature	0 °C ~ +50 °C
Ambient humidity	35 % ~ 85 % (non-condensing)
Vibration resistance	0,5 G
Duty cycle	100 %

Dimensions

Stepper drive → EtherCAT protocol

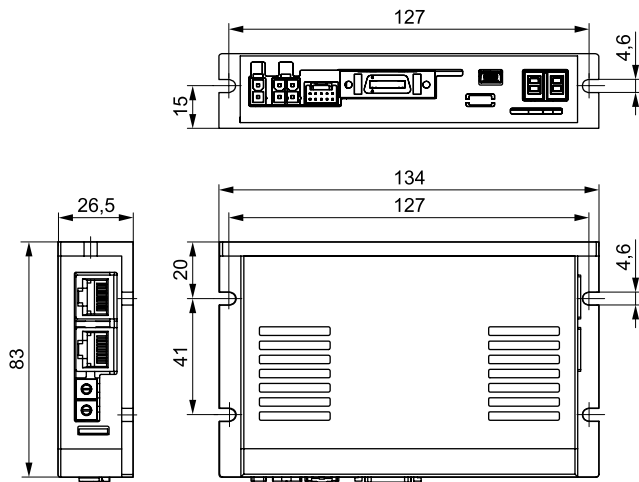

Stepper drive → Ethernet based communication

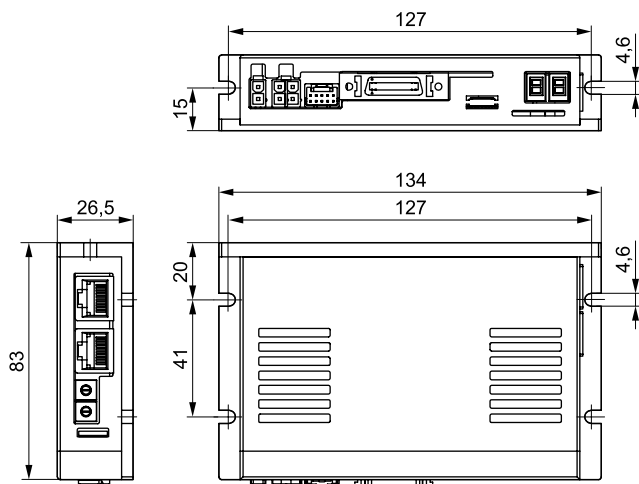

Stepper drive → Pulse-direction control

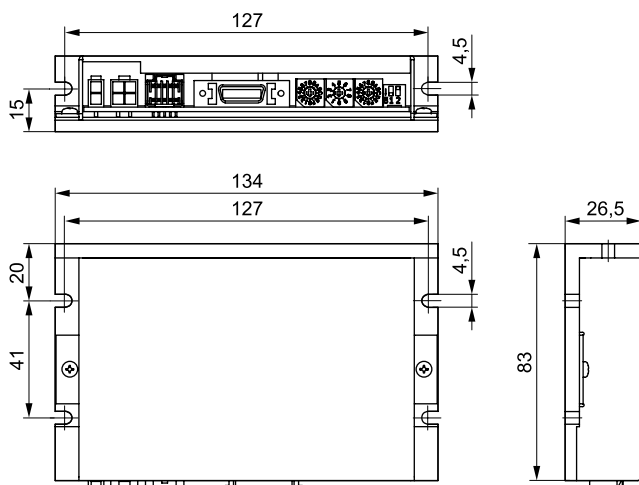

Drive-motor cables

Drive to motor cables in general consist of:

- 1 - a motor cable
- 2 - an encoder cable
- 3 - a brake cable (only if a motor with brake is used).

For the stepper motor size of 28 motor and brake cables are combined in one cable.

Additional cable, i.e. brake to terminal cable is included for the case of the motor (□28) with the brake.

Cables identification and compatibility

Designation	Cable type	Compatible with
STCF-M-_8-...*	Motor; Brake	STMN-28-...; STMN-28-...-B
STCF-M-_12-...	Motor	STMN-42-...; STMN-42-...-B; STMN-56-...; STMN-56-...-B
STCF-BT-02*	Brake to terminal	STMN-28-...-B
STCF-B-_8-...	Brake	STMN-42-...-B; STMN-56-...-B
STCF-E-_8-...*	Encoder	STMN-28-...; STMN-28-...-B
STCF-E-_12-...	Encoder	STMN-42-...; STMN-42-...-B; STMN-56-...; STMN-56-...-B

*Available soon.

Technical data

Stepper motor size of 28 mm

Available soon.

Stepper motor size of 42 and 56 mm

Designation	Length [m]	Cable diameter D [mm]	Material, color	Bending radius (dyn.) [mm]	Shielded?
STCF-M-_12-...	3, 5, 10	5,1	TPE, black	min. 7,5 × D	Yes
STCF-B-_8-...	3, 5, 10	4,5	TPE, black	min. 7,5 × D	Yes
STCF-E-_12-...	3, 5, 10	6,7	TPE, black	min. 7,5 × D	Yes

Operating conditions

Ambient temperature (fixed laying)	-40 °C ~ +70 °C
Ambient temperature (flexible application)	5 °C ~ +70 °C

Dimensions

Drive to motor cables for the stepper motors (only for the STDF and STMN motors).

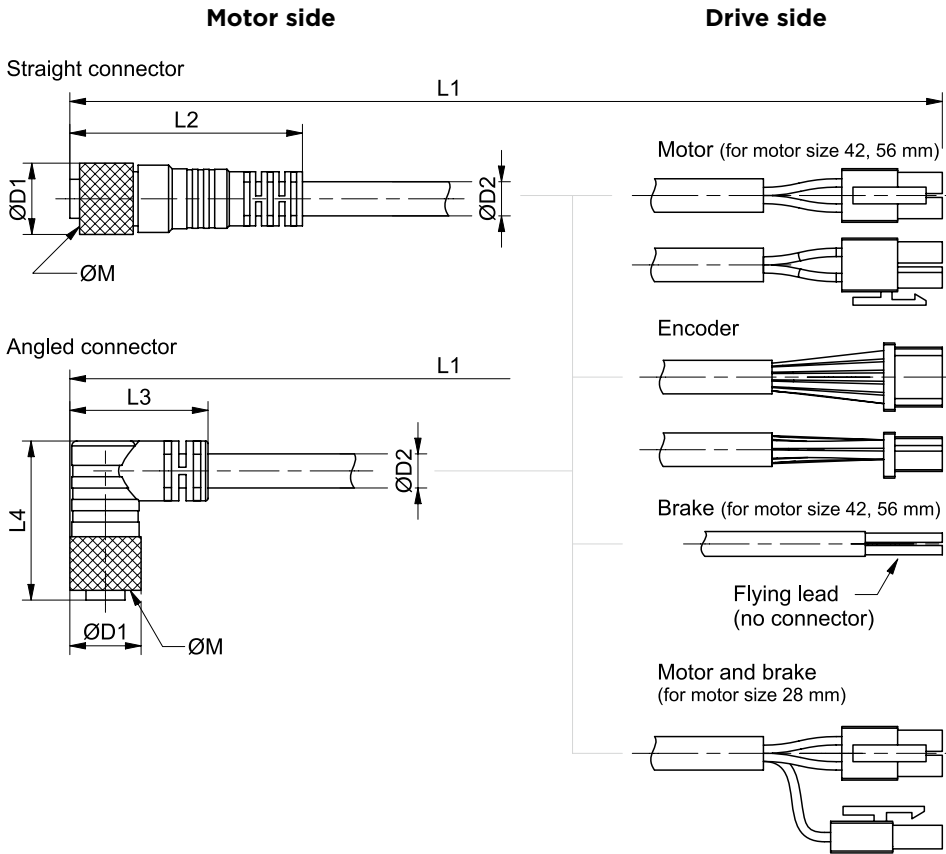

Brake to terminal cables

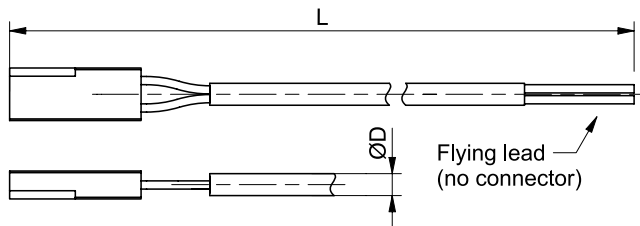

Motor, encoder, brake and brake to terminal cables

Designation	Cable type	L [m]	L1 [m]	L2 [mm]	L3 [mm]	L4 [mm]	$\varnothing D$ [mm]	$\varnothing D1$ [mm]	$\varnothing D2$ [mm]	$\varnothing M$ [mm]
STCF-M-_8-...	Motor	-	-	-	-	-	-	-	-	-
STCF-M-_12-...	Motor	-	3, 5, 10	47,7	28,4	32,6	-	14,6	5,1	M12
STCF-B-_8-...	Brake	-	3, 5, 10	41,7	30,9	25,2	-	9,9	4,5	M8
STCF-BT-02	Brake to terminal	2	-	-	-	-	Available soon	-	-	-
STCF-E-_8-...	Encoder	-	-	-	-	-	-	-	-	-
STCF-E-_12-...	Encoder	-	3, 5, 10	47,7	28,4	32,6	-	14,6	6,7	M12

Power and signal cables

Power cable is used for supplying the power from power supply to the drive. Signal cable is mandatory for the following cases:

- 1 - If a motor with brake is used
- 2 - If a pulse-direction drive control is used
- 3 - If the limit switches are used.

Cables identification and compatibility

Designation	Cable type	Compatible with
STCF-P-02	Power	STDF-...-EC; STDF-...-EN; STDF-...-PD
STCF-S-EC-02	Signal	STDF-...-EC
STCF-S-EN-02	Signal	STDF-...-EN
STCF-S-PD-02	Signal	STDF-...-PD

Technical data

Designation	Length [m]	Cable diameter [mm]	Material, color	Shielded?
STCF-P-02	2	4,6	PVC, black	Yes
STCF-S-EC-02	2	6,4	PVC, black	Yes
STCF-S-EN-02	2	6,9	PVC, black	Yes
STCF-S-PD-02	2	6,4	PVC, black	Yes

Dimensions

Power cables for the stepper motors (only for the STDF drives)

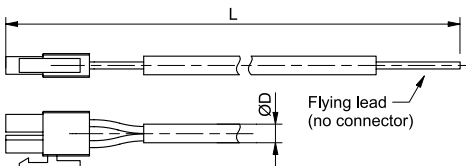

Signal cables for the stepper motors (only for the STDF drives)

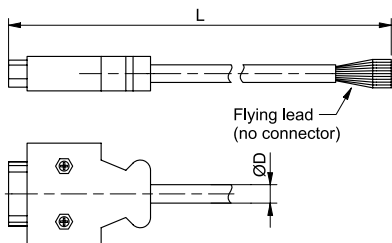

Designation	Cable type	L [m]	ØD [mm]
STCF-P-02	Power	2	4,6
STCF-S-EC-02	Signal	2	6,4
STCF-S-EN-02	Signal	2	6,9
STCF-S-PD-02	Signal	2	6,4

Mounting examples

Mini electric cylinders MCE and sliders MSCE can easily be combined to the multi-axis systems by using the standard accessories. Already prepared mounting holes on the front plate/slide of the MSCE, guiding unit GUC, and mounting slots on the profiles allow various combinations of MCE and MSCE without additional connection plates.

In the following, compatibility of the mini electric cylinders and sliders are presented.

For non-standard combinations, configurations, or custom connection elements, please contact us.

x-y configuration with the x-axis: MCE + the guiding unit GUC

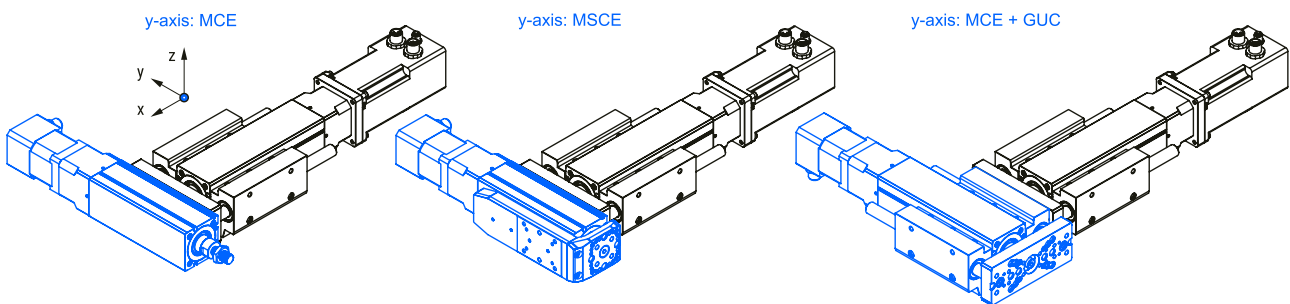

Mini electric cylinders and sliders can be combined by using the slot nuts together with the standard screws. For the case, where the y-axis is MCE+GUC, only the standard screws can be used.

Configuration		y-axis								
		MCE			MSCE			MCE + GUC		
x-axis	Size	25	32	45	25	32	45	25	32	45
MCE + GUC	25	•	-	-	•	-	-	•	-	-
	32	•	•	-	•	•	-	•	•	-
	45	•	•	•	•	•	•	•	•	•

x-z configuration with the x-axis: MCE + the guiding unit GUC

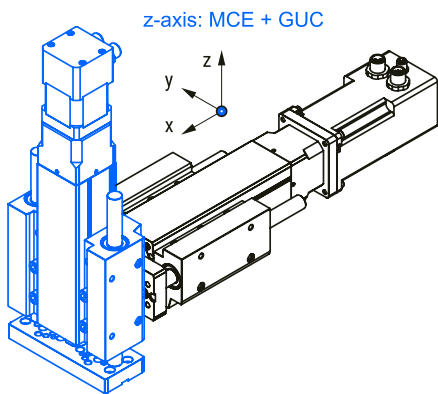

Mini electric cylinders with GUC can be combined by using the standard screws.

Configuration		z-axis MCE + GUC		
x-axis	Size	25	32	45
MCE + GUC	25	•	-	-
	32	•	•	-
	45	•	•	•

x-y configuration with the x-axis: MSCE (y-axis is mounted to the front plate)

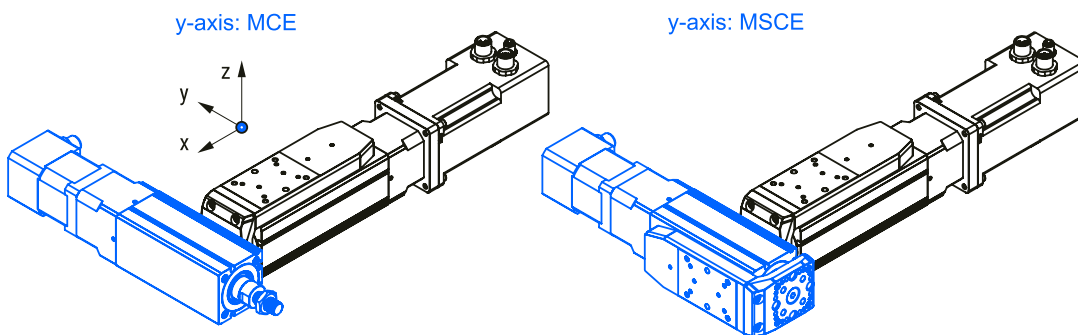

Mini electric cylinders and sliders can be combined by using the slot nuts together with the standard screws.

Configuration		y-axis					
x-axis	Size	25	MCE 32	45	25	MSCE 32	45
MSCE: front plate	25	•	-	-	•	-	-
	32	•	•	-	•	•	-
	45	•	•	•	•	•	•

x-y configuration with the x-axis: MSCE (y-axis is mounted to the slide)

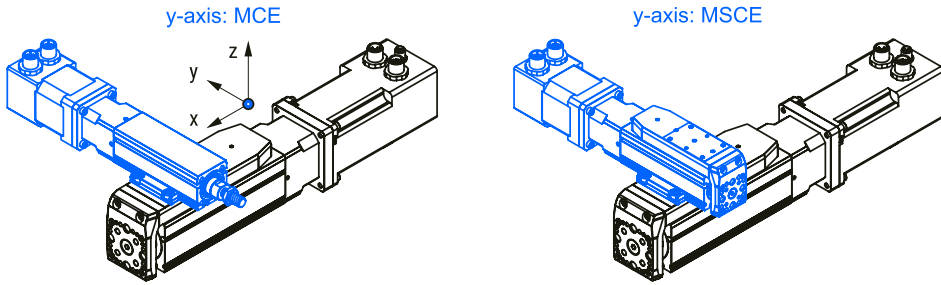

Mini electric cylinders and sliders can be combined by using the clamping fixtures together with the standard screws.

Configuration		y-axis					
x-axis	Size	25	MCE 32	45	25	MSCE 32	45
MSCE: slide	25	-	-	-	-	-	-
	32	•	-	-	•	-	-
	45	•	•	-	•	•	-

x-z configuration with the x-axis: MSCE (z-axis is mounted to the front plate)

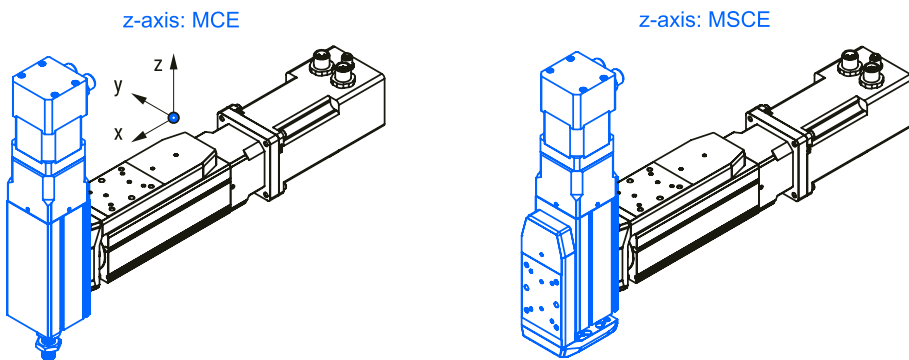

Mini electric cylinders and sliders can be combined by using the slot nuts together with the standard screws.

Configuration		z-axis					
x-axis	Size	25	MCE 32	45	25	MSCE 32	45
MSCE: front plate	25	•	-	-	•	-	-
	32	•	•	-	•	•	-
	45	•	•	•	•	•	•

Linear guiding

Dynamic load capacity, dynamic moments and maximum permissible loads of the linear guiding system integrated into the mini electric slider refer to the centre of the linear guides.

The applied loading condition needs to be calculated, with respect to the centre of the linear guides. The presented attachment distances, measured from the centre of the linear guides, together with an absolute position of the slider must be taken into consideration.

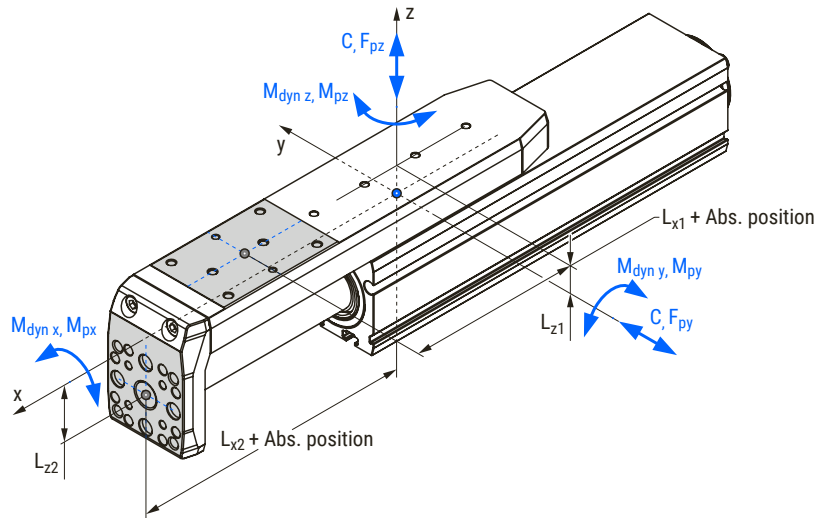

Valid for mini electric slider MSCE.

Designation	Attachment distances			
	Slide		Front plate	
	L_{x1} [mm]	L_{z1} [mm]	L_{x2} [mm]	L_{z2} [mm]
MSCE 25	0,0	7,5	34,0	-16,5
MSCE 32	0,0	7,7	39,0	-21,3
MSCE 45	0,0	10,6	50,5	-27,4

Abs. position	Absolute position [mm]
C	Dynamic load capacity [N]
$M_{dyn\ x}$	Dynamic moment about the x axis [Nm]
$M_{dyn\ y}$	Dynamic moment about the y axis [Nm]
$M_{dyn\ z}$	Dynamic moment about the z axis [Nm]
F_{py}	Max. permissible force in the y direction [N]
F_{pz}	Max. permissible force in the z direction [N]
M_{px}	Max. permissible moment about the x axis [Nm]
M_{py}	Max. permissible moment about the y axis [Nm]
M_{pz}	Max. permissible moment about the z axis [Nm]

Permissible load

Permissible load factor f_{pg}

A permissible load factor of the linear guiding system f_{pg} must never exceed the value of 1.

$$f_{pg} = \frac{|F_y|}{F_{py}} + \frac{|F_z|}{F_{pz}} + \frac{|M_x|}{M_{px}} + \frac{|M_y|}{M_{py}} + \frac{|M_z|}{M_{pz}} \leq 1$$

f_{pg}	Permissible load factor
F_y	Applied force in the y direction [N]
F_z	Applied force in the z direction [N]
M_x	Applied moment about the x axis [Nm]
M_y	Applied moment about the y axis [Nm]
M_z	Applied moment about the z axis [Nm]

Service life

Service life calculation

$$L_{km\ g} = \left(\frac{1}{f_{vm\ g}} \right)^3 \cdot 10^2$$

$L_{km\ g}$	Service life of the linear guiding system [km]
$f_{vm\ g}$	Mean load comparison factor

Mean load comparison factor $f_{vm\ g}$ as a function of service life $L_{km\ g}$

Diagram represents the theoretically determined service life of the linear guiding system when the mean load comparison factor $f_{vm\ g}$ is considered.

It should be noted that the application conditions may have a significant effect on the service life.

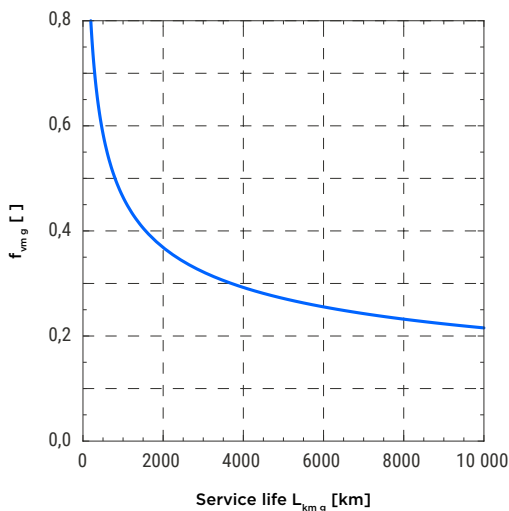

Mean load comparison factor f_{vmg}

$$f_{vmg} = \sqrt[3]{\frac{f_{v1g}^3 \cdot s_1 + f_{v2g}^3 \cdot s_2 + \dots + f_{vng}^3 \cdot s_n}{s_1 + s_2 + \dots + s_n}}$$

$f_{vi g}$	i-th load comparison factor of a given loading regime $f_{v g}(s)$, $i \in \{1, 2, \dots, n\}$
s_i	i-th travel path of a given loading regime $f_{v g}(s)$, $i \in \{1, 2, \dots, n\}$

Loading regime $f_{v g}(s)$

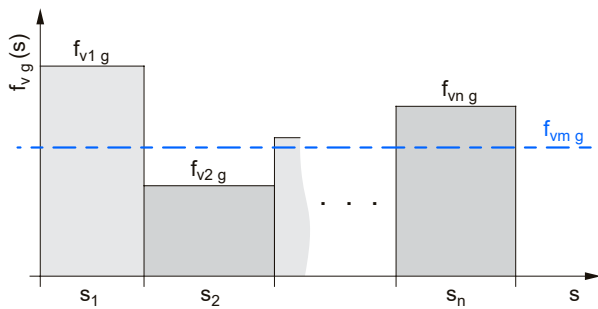

Load comparison factor $f_{v g}$

$$f_{v g} = \frac{|F_y|}{C} + \frac{|F_z|}{C} + \frac{|M_x|}{M_{dyn x}} + \frac{|M_y|}{M_{dyn y}} + \frac{|M_z|}{M_{dyn z}}$$

$f_{v g}$	Load comparison factor
-----------	------------------------

Mean dynamic safety factor f_{smg}

The safety factor depends on the application and its requested safety. A minimum dynamic safety factor of 5,0 or more is recommended.

$$f_{smg} = \frac{1}{f_{vmg}}$$

$f_{sm g}$	Mean dynamic safety factor
------------	----------------------------

Ball screw drive

Valid for the mini electric cylinder MCE and the slider MSCE.

Permissible load

Permissible load factor $f_{p\ bs}$

A permissible load factor of the ball screw drive $f_{p\ bs}$ must never exceed the value of 1.

$$f_{p\ bs} = \frac{|F_x|}{F_{pa}} \leq 1$$

$f_{p\ bs}$	Permissible load factor
F_{pa}	Max. permissible axial load [N]
F_x	Applied force in the x direction [N]

Service life

Service life calculation

$$L_{km\ bs} = \left(\frac{1}{f_{vm\ bs}} \right)^3 \cdot l$$

$L_{km\ bs}$	Service life [km]
$f_{vm\ bs}$	Mean load comparison factor
l	Ball screw lead [mm]

Mean load comparison factor $f_{vm\ bs}$ as a function of service life $L_{km\ bs}$

Diagram represents the theoretically determined service life of the ball screw drive when the mean load comparison factor $f_{vm\ bs}$ is considered.

It should be noted that the application conditions may have a significant effect on the service life.

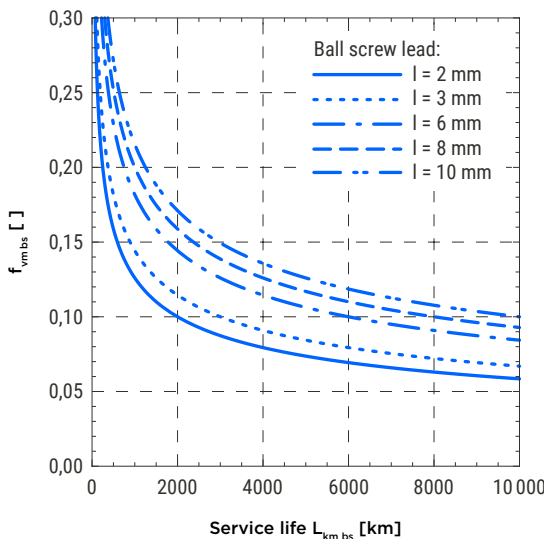

Mean load comparison factor $f_{vm\ bs}$

$$f_{vm\ bs} = \sqrt[3]{\frac{f_{v1\ bs}^3 \cdot s_1 + f_{v2\ bs}^3 \cdot s_2 + \dots + f_{vn\ bs}^3 \cdot s_n}{s_1 + s_2 + \dots + s_n}}$$

$f_{vi\ bs}$	i-th load comparison factor of a given loading regime $f_{v\ bs}(s)$, $i \in \{1, 2, \dots, n\}$
s_i	i-th travel path of a given loading regime $f_{v\ bs}(s)$, $i \in \{1, 2, \dots, n\}$

Loading regime $f_{v\ bs}(s)$

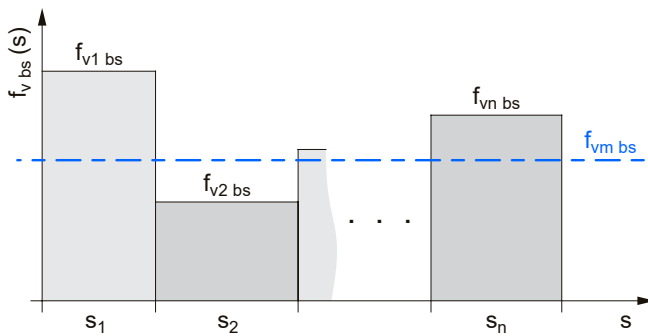

Load comparison factor $f_{v\ bs}$

$$f_{v\ bs} = \frac{|F_x|}{C_a}$$

$f_{v\ bs}$	Load comparison factor
C_a	Dynamic axial load capacity [N]

Mean dynamic safety factor $f_{sm\ bs}$

The safety factor depends on the application and its requested safety. A minimum dynamic safety factor of 5,0 or more is recommended.

$$f_{sm\ bs} = \frac{1}{f_{vm\ bs}}$$

$f_{sm\ bs}$	Mean dynamic safety factor
--------------	----------------------------

Mini electric cylinder MCE

Service life of the mini electric cylinder is the calculated service life of the ball screw drive $L_{km\ bs}$.

$$L_{km} = L_{km\ bs}$$

 L_{km}

Service life of the mini electric cylinder or slider [km]

Mini electric slider MSCE

Service life of the mini electric slider is the minimum value between the calculated service life of the linear guiding system $L_{km\ g}$ and the ball screw drive $L_{km\ bs}$.

$$L_{km} = \text{Min} [L_{km\ g}, L_{km\ bs}]$$

 L_{km}

Service life of the mini electric cylinder or slider [km]

Calculations

Load torque

The load torque is a function of an applied axial load (force) to the mini electric cylinder or slider and can be calculated as follows:

$$M_{load} = \frac{F_x \cdot l}{2000 \cdot \pi \cdot \eta}$$

M_{load}	Load torque [Nm]
F_x	Applied axial force [N]
l	Ball screw lead [mm]
η	Mechanical efficiency $\approx 0,9$

It should be noted that the load torque M_{load} must never exceed the maximum drive torque M_p (or $M_{p,MSD}$ if a motor side drive MSD is taken into consideration).

MCE

MCE - 45 - 1003 - 150 - F - E20 - O - AB - AU - AA - AB - AA

Series:
MCE

Size:
- 25
- 32
- 45

Ball screw size:
- MCE 25: $\varnothing 6 \times 2$, $\varnothing 6 \times 6$
- MCE 32: $\varnothing 8 \times 2$, $\varnothing 8 \times 8$
- MCE 45: $\varnothing 10 \times 3$, $\varnothing 10 \times 10$

Absolute stroke [mm]:
(Absolute stroke = Effective stroke + 2 × Safety stroke)
- 25, 50, 75, 100, 125, 150, 175, 200

Option 1:
- Leave blank: Standard (male thread)
- F: Female thread

Option 2:
- Leave blank: Without
- Extended piston rod E [mm]
(Max. extended piston rod: Emax = 100 mm)

Guiding unit:
- O: Without a guiding unit
- B: With a guiding unit GUC (ball bushes)

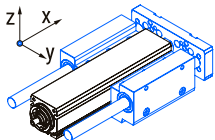

Guiding unit GUC requires a female thread on the piston rod end (Option 1 F).

Motor type and size:
- Leave blank: Without a motor

Motor type: _____ **A** **B**
- A: Stepper motor without a brake
- B: Stepper motor with a brake

Motor size □: _____
- A: 28 mm (Available soon)
- B: 42 mm
- C: 56 mm

Available sizes:
- MSCE 25: 28
- MSCE 32: 28, 42
- MSCE 45: 42, 56

Motor mounting option:

- Leave blank: Without a motor

Mounting option:

- A: With a motor adapter VK
- B: With a motor side drive MSD facing up
- C: With a motor side drive MSD facing right
- D: With a motor side drive MSD facing down
- E: With a motor side drive MSD facing left

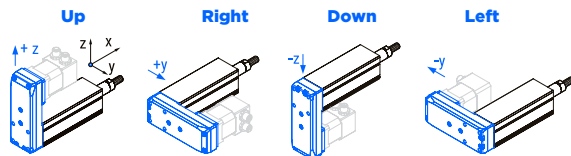

Direction of the motor connectors:

- U: Connectors facing up
- R: Connectors facing right
- D: Connectors facing down
- L: Connectors facing left

If a guiding unit GUC is considered, the motor side drive MSD can only be facing in the up or down directions, otherwise, the motor and the guiding unit may collide!

In combination with a motor adapter VK

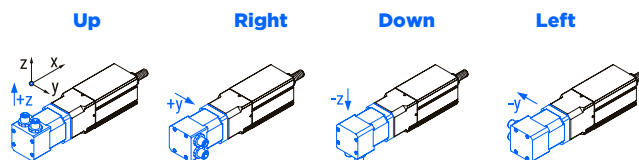

In combination with a motor side drive MSD

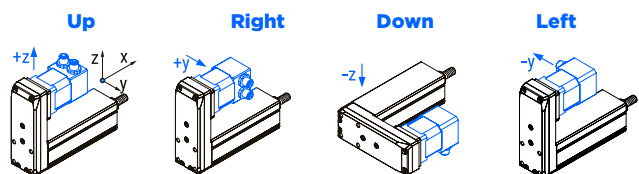

When using the motor side drive MSD, the connectors can not be facing the MCE otherwise, the connectors and MCE may collide. These combinations are: BD, CL, DU and ER.

Drive option:

- Leave blank: Without a motor or drive

Drive type:

- A: Stepper

Drive protocol/control:

- A: EtherCAT
- B: Ethernet based communication
- C: Pulse-direction control

Drive-motor cables option:

- Leave blank: Without a motor or drive
- 00: Without the cables

Cables type:

- A: Robotic with a straight plug
- B: Robotic with an angled plug

Cables length:

- A: 3 m
- B: 5 m
- C: 10 m

Power and signal cables:

- Leave blank: Without a motor or drive

Power cable:

- 0: Without a power cable
- A: With a power cable

Signal cable:

- 0: Without a signal cable
- A: With a signal cable

MSCE

MSCE - 45 - 1003 - 150 - AB - AU - AA - AB - AA

Series:
MSCE

Size:
- 25
- 32
- 45

Ball screw size:
- MSCE 25: $\varnothing 6 \times 2$, $\varnothing 6 \times 6$
- MSCE 32: $\varnothing 8 \times 2$, $\varnothing 8 \times 8$
- MSCE 45: $\varnothing 10 \times 3$, $\varnothing 10 \times 10$

Absolute stroke [mm]:
(Absolute stroke = Effective stroke + 2 × Safety stroke)
- 25, 50, 75, 100, 125, 150, 175, 200

Motor type and size:
- Leave blank: Without a motor

Motor type: _____ **A** **B**
- A: Stepper motor without a brake
- B: Stepper motor with a brake

Motor size □: _____
- A: 28 mm (Available soon)
- B: 42 mm
- C: 56 mm

Available sizes:
- MSCE 25: 28
- MSCE 32: 28, 42
- MSCE 45: 42, 56

Motor mounting option:

- Leave blank: Without a motor

Mounting option:

- A: With a motor adapter VK
- B: With a motor side drive MSD facing up
- C: With a motor side drive MSD facing right
- D: With a motor side drive MSD facing down
- E: With a motor side drive MSD facing left

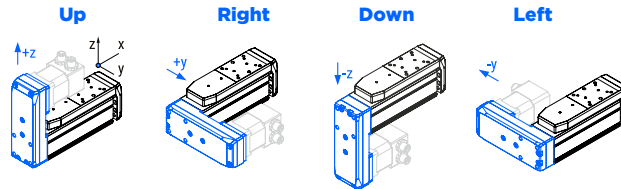

Direction of the motor connectors:

- U: Connectors facing up
- R: Connectors facing right
- D: Connectors facing down
- L: Connectors facing left

In combination with a motor adapter VK

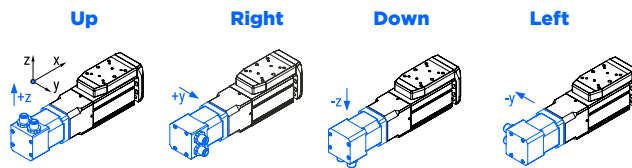

In combination with a motor side drive MSD

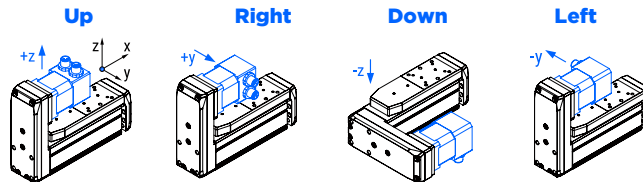

When using the motor side drive MSD, the connectors can not be facing the MCE otherwise, the connectors and MCE may collide. These combinations are: BD, CL, DU and ER.

Drive option:

- Leave blank: Without a motor or drive

Drive type:

- A: Stepper

Drive protocol/control:

- A: EtherCAT
- B: Ethernet based communication
- C: Pulse-direction control

Drive-motor cables option:

- Leave blank: Without a motor or drive
- 00: Without the cables

Cables type:

- A: Robotic with a straight plug
- B: Robotic with an angled plug

Cables length:

- A: 3 m
- B: 5 m
- C: 10 m

Power and signal cables:

- Leave blank: Without a motor or drive

Power cable:

- 0: Without a power cable
- A: With a power cable

Signal cable:

- 0: Without a signal cable
- A: With a signal cable

Motor Adapter VK

VK - MG 32 - 42,3 - 43,8 - 22 - 2 - 24 - 4,5 - M3 - 0 - 0 - 45

Motor adapter	A	ØB	ØC	M	L1	H	ØO	V	ØZ	α
Mini series: - MG	Motor dimensions [mm]									[°]
Size: - 25 - 32 - 45										

Dimension ØO is also used for tapped holes. In case of tapped holes, prefix M must be applied.

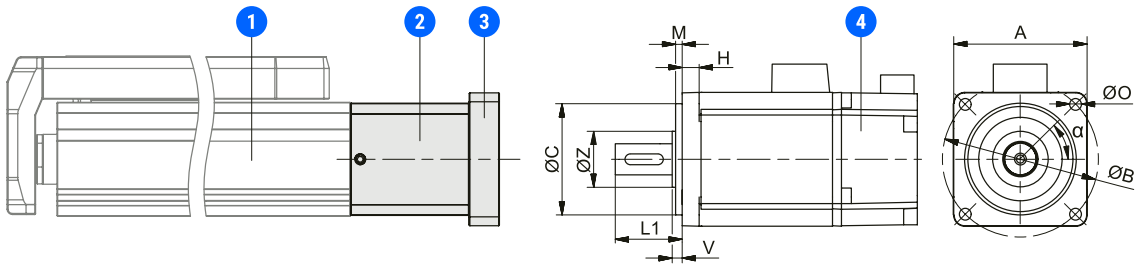

- 1 - MCE/MSCE
 - 2 - Motor adapter housing
 - 3 - Motor adapter flange
 - 4 - Motor
- } Motor adapter VK

Motor side drive MSD with a timing belt

MSD - MG 32 - T2 - 42,3 - 43,8 - 22 - 2 - 24 - 5 - 4,5 - M3 - 0 - 0 - 45

Motor side drive

Mini series:

- MG

Size:

- 25

- 32

- 45

Type

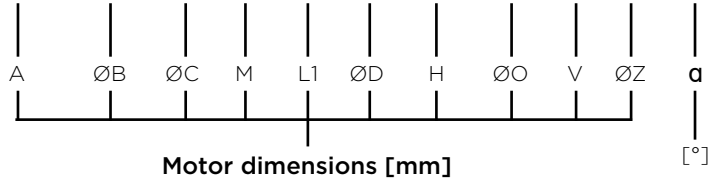

Dimension ØO is also used for tapped holes. In case of tapped holes, prefix M must be applied.

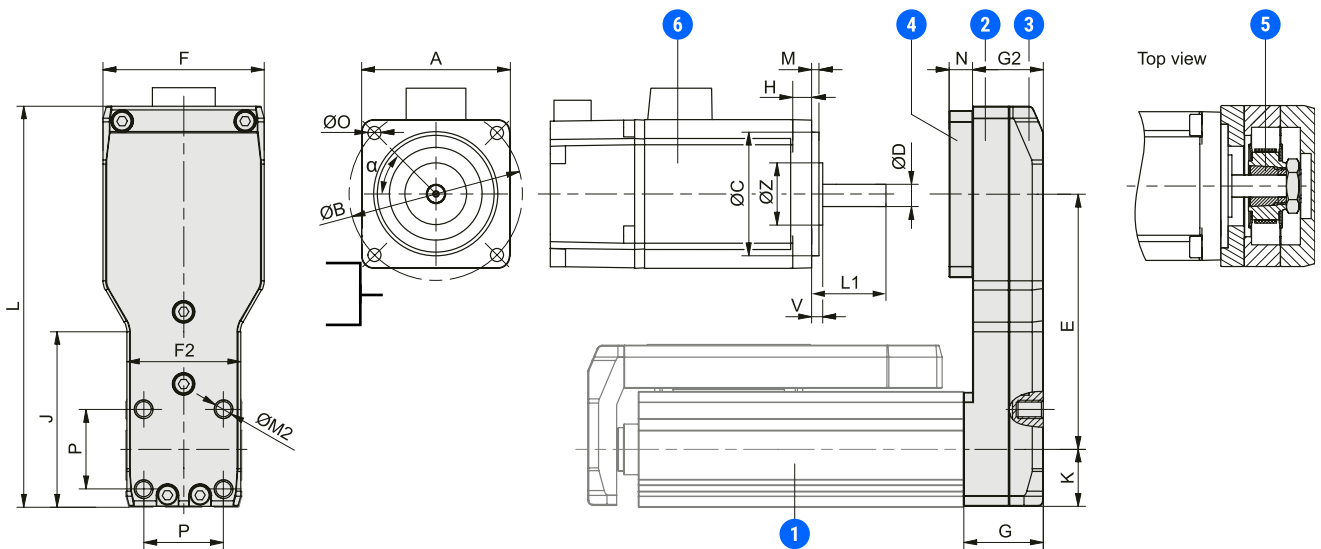

- 1 - MCE/MSCE
 - 2 - Motor side drive housing
 - 3 - Motor side drive cap
 - 4 - Motor side drive tensioning plate
 - 5 - Clamping set
 - 6 - Motor
- Motor side drive MSD

Guiding Unit

	GUC	- 32	- 125	- BB
Guiding unit				
Size: - 25 - 32 - 45				
GUC stroke: absolute stroke + extendend piston rod E [mm]				
Option: - BB: with the ball bushes				

GUC stroke: absolute stroke + extended piston rod E = max. 300 mm.
For the guiding unit stroke over 300 mm, please contact us.

Couplings

COUPLING - EKL5 - A - F5 - F6PFN

Coupling

Coupling type/size:

- 2
- 5

Elastomer insert type:

- A

Hole diameter

[mm]

Option:

- PFN: with the keyway
- Leave blank: without the keyway

**ALWAYS THE RIGHT
SOLUTION AT THE RIGHT TIME.**

ROLLCO

LINEAR SOLUTIONS **YOUR** WAY

With reliability, competence and commitment Rollco rapidly delivers the right solutions and components to create safe and cost-effective automation and linear movement.

Rollco AB

Box 22234
Ekvändan 3
250 24 Helsingborg
Sweden
Tel. +46 42 15 00 40
www.rollco.se

Rollco A/S

Skomagervej 13 E
7100 Vejle
Denmark
Tel. +45 75 52 26 66
www.rollco.dk

Rollco Oy

Sarankulmankatu 12
33900 Tampere
Finland
Tel. +358 207 57 97 90
www.rollco.fi

Rollco Norge AS

Industrigata 6
3414 Lierstrada
Norway
Tel. +47 32 84 00 34
www.rollco.no